



User Guide

AC1750 Wireless Dual Band Gigabit Router
Archer C7/Archer A7

Contents

About This Guide	1
Chapter 1. Get to Know About Your Router	3
1.1. Product Overview.....	4
1.2. Appearance	4
1.2.1.The Front Panel	4
1.2.2.The Back Panel.....	5
Chapter 2. Connect the Hardware	7
2.1. Position Your Router	8
2.2. Connect Your Router.....	8
Chapter 3. Log In to Your Router.....	11
Chapter 4. Set Up Internet Connection	13
4.1. Use Quick Setup Wizard	14
4.2. Manually Set up Your Internet Connection	14
4.3. Set Up an IPv6 Internet Connection	18
4.4. Configure the Router in Access Point Mode	21
Chapter 5. TP-Link Cloud Service	23
5.1. Register a TP-Link ID.....	24
5.2. Change Your TP-Link ID Information.....	24
5.3. Manage the User TP-Link IDs	25
5.3.1.Add TP-Link ID to Manage the Router.....	26
5.3.2.Remove TP-Link ID(s) from Managing the Router.....	26
5.4. Manage the Router via the TP-Link Tether App	27
Chapter 6. Work with Alexa and IFTTT	28
Chapter 7. OneMesh with Seamless Roaming	30
7.1. Set Up a OneMesh Network.....	31
7.2. Manage Devices in the OneMesh Network	32
Chapter 8. Guest Network.....	35

8. 1.	Create a Network for Guests	36
8. 2.	Customize Guest Network Options.....	36
Chapter 9. USB Settings.....		38
9. 1.	Access the USB Storage Device	39
9. 1. 1.	Access the USB Device Locally.....	39
9. 1. 2.	Access the USB Device Remotely	40
9. 1. 3.	Customize the Access Settings.....	42
9. 2.	Media Sharing	46
9. 3.	Offline Download	47
Chapter 10.Parental Controls		49
10. 1.	Set Up Access Restrictions	50
10. 2.	Monitor Internet Usage	52
Chapter 11.QoS.....		54
Chapter 12.Network Security		56
12. 1.	Protect the Network from Cyber Attacks	57
12. 2.	Access Control	58
12. 3.	IP & MAC Binding	59
Chapter 13.NAT Forwarding.....		61
13. 1.	Share Local Resources on the Internet by Virtual Servers.....	62
13. 2.	Open Ports Dynamically by Port Triggering	63
13. 3.	Make Applications Free from Port Restriction by DMZ	64
13. 4.	Make Xbox Online Games Run Smoothly by UPnP	65
Chapter 14.VPN Server		67
14. 1.	Use OpenVPN to Access Your Home Network.....	68
14. 1. 1.	Step1. Set up OpenVPN Server on Your Router	68
14. 1. 2.	Step 2. Configure OpenVPN Connection on Your Remote Device	69
14. 2.	Use PPTP VPN to Access Your Home Network	69
14. 2. 1.	Step 1. Set up PPTP VPN Server on Your Router	70
14. 2. 2.	Step 2. Configure PPTP VPN Connection on Your Remote Device....	71
Chapter 15.Customize Your Network Settings.....		75
15. 1.	Change the LAN Settings	76

15. 2.	Configure to Support IPTV Service.....	76
15. 3.	Specify DHCP Server Settings.....	77
15. 4.	Set Up a Dynamic DNS Service Account.....	79
15. 5.	Create Static Routes.....	81
15. 6.	Specify Wireless Settings.....	83
15. 7.	Use WPS for Wireless Connection.....	85
15. 7. 1.	Set the Router's PIN.....	85
15. 7. 2.	Use the WPS Wizard for Wi-Fi Connections.....	85

Chapter 16. Manage the Router 87

16. 1.	Set Up System Time.....	88
16. 2.	Control LEDs.....	89
16. 3.	Test the Network Connectivity.....	90
16. 4.	Upgrade the Firmware.....	91
16. 4. 1.	Online Upgrade.....	91
16. 4. 2.	Manual Upgrade.....	92
16. 4. 3.	Restore Interrupted Upgrade after Power Failure.....	93
16. 5.	Backup and Restore Configuration Settings.....	93
16. 6.	Set the Router to Reboot Regularly.....	95
16. 7.	Change the Login Password.....	95
16. 8.	Password Recovery.....	96
16. 9.	Local Management.....	97
16. 10.	Remote Management.....	98
16. 11.	System Log.....	99
16. 12.	Monitor the Internet Traffic Statistics.....	101

FAQ..... 103







About This Guide

This guide is a complement of Quick Installation Guide. The Quick Installation Guide instructs you on quick Internet setup, and this guide provides details of each function and shows you the way to configure these functions appropriate to your needs.

When using this guide, please notice that features of the router may vary slightly depending on the model and software version you have, and on your location, language, and Internet service provider. All screenshots, images, parameters and descriptions documented in this guide are used for demonstration only.

Conventions

In this guide the following conventions are used:

Convention	Description
<u>Underlined</u>	Underlined words or phrases are hyperlinks. You can click to redirect to a website or a specific section.
Teal	Contents to be emphasized and texts on the web page are in teal, including the menus, items, buttons, etc.
>	The menu structures to show the path to load the corresponding page. For example, Advanced > Wireless > MAC Filtering means the MAC Filtering function page is under the Wireless menu that is located in the Advanced tab.
 Note:	Ignoring this type of note might result in a malfunction or damage to the device.
 Tips:	Indicates important information that helps you make better use of your device.
symbols on the web page	<ul style="list-style-type: none"> click to edit the corresponding entry. click to delete the corresponding entry. click to enable or disable the corresponding entry. click to view more information about items on the page.

More Info

The latest software, management app and utility can be found at [Download Center](https://www.tp-link.com/support) at <https://www.tp-link.com/support>.

The Quick Installation Guide can be found where you find this guide or inside the package of the router.

Specifications can be found on the product page at <https://www.tp-link.com>.

A community is provided for you to discuss our products at <https://community.tp-link.com>.

Our Technical Support contact information can be found at the [Contact Technical Support](https://www.tp-link.com/support) page at <https://www.tp-link.com/support>.

Speed/Coverage Disclaimer

*Maximum wireless signal rates are the physical rates derived from IEEE Standard 802.11 specifications. Actual wireless data throughput and wireless coverage are not guaranteed and will vary as a result of 1) environmental factors, including building materials, physical objects, and obstacles, 2) network conditions, including local interference, volume and density of traffic, product location, network complexity, and network overhead, and 3) client limitations, including rated performance, location, connection, quality, and client condition.

Chapter 1

Get to Know About Your Router

This chapter introduces what the router can do and shows its appearance.

It contains the following sections:

- [Product Overview](#)
- [Appearance](#)

1.1. Product Overview

The TP-Link router is designed to fully meet the need of Small Office/Home Office (SOHO) networks and users demanding higher networking performance. The powerful antennas ensure continuous Wi-Fi signal to all your devices while boosting widespread coverage throughout your home, and the built-in Ethernet ports supply high-speed connection to your wired devices.

Moreover, it is simple and convenient to set up and use the TP-Link router due to its intuitive web interface and the powerful Tether app.

1.2. Appearance

1.2.1. The Front Panel



The router's LEDs (view from left to right) are located on the front panel. You can check the router's working status by following the LED Explanation table.

LED Explanation

Name	Status	Indication
⏻ (Power)	On	The system has started up successfully.
	Flashing	The system is starting up or the firmware is being upgraded. Do not disconnect or power off your router.
	Off	Power is off.

Name	Status	Indication
📶 (2.4GHz Wireless)	On	The 2.4GHz wireless band is enabled.
	Off	The 2.4GHz wireless band is disabled.
📶 (5GHz Wireless)	On	The 5GHz wireless band is enabled.
	Off	The 5GHz wireless band is disabled.
🌐 (Internet)	Green On	Internet service is available.
	Orange On	The router's Internet port is connected, but the internet service is not available.
	Off	The router's Internet port is unplugged.
🖨️ (Ethernet)	On	A powered-on device is connected to the router's corresponding Ethernet port.
	Off	No powered-on device is connected to the router's corresponding Ethernet port.
🔌 (USB)	On	The inserted USB device is ready to use.
	Flashing	A USB device is being identified.
	Off	No device is plugged into the USB port.
↻ (WPS)	On/Off	This light remains on for 5 minutes when a WPS connection is established, then turns off.
	Flashing	WPS connection is in progress. This may take up to 2 minutes.

1.2.2. The Back Panel



The router's ports (view from left to right) are located on the rear panel.

Item	Description
Power Port	For connecting the router to a power socket via the provided power adapter.
Power On/Off Button	Press this button to power on or off the router.
Reset Button	Press and hold this button until the Power LED binks to reset the router to its factory default settings.
USB Port	For connecting to a USB device.
Internet Port	For connecting to a DSL/Cable modem, or an Ethernet jack.
Ethernet Ports (1/2/3/4)	For connecting your PC or other Ethernet network devices to the router.
WPS/Wi-Fi On/Off	Press this button, and immediately press the WPS button on your device. The WPS LED of the router should change from flashing to solid on, indicating successful WPS connection.
	Press and hold the Wi-Fi button for about 2 seconds to turn on or off the wireless function of your router.
Antennas	Used for wireless operation and data transmit. Upright them for the best Wi-Fi performance.

Chapter 2

Connect the Hardware

This chapter contains the following sections:

- [Position Your Router](#)
- [Connect Your Router](#)

2.1. Position Your Router

- The product should not be located in a place where it will be exposed to moisture or excessive heat.
- Place the router in a location where it can be connected to multiple devices as well as to a power source.
- Make sure the cables and power cord are safely placed out of the way so they do not create a tripping hazard.
- The router can be placed on a shelf or desktop.
- Keep the router away from devices with strong electromagnetic reference, such as Bluetooth devices, cordless phones and microwaves.

2.2. Connect Your Router

Follow the steps below to connect your router.

If your internet connection is through an Ethernet cable directly from the wall instead of through a DSL / Cable / Satellite modem, connect the Ethernet cable to the router's Internet port, and then follow Step 4 and 5 to complete the hardware connection.

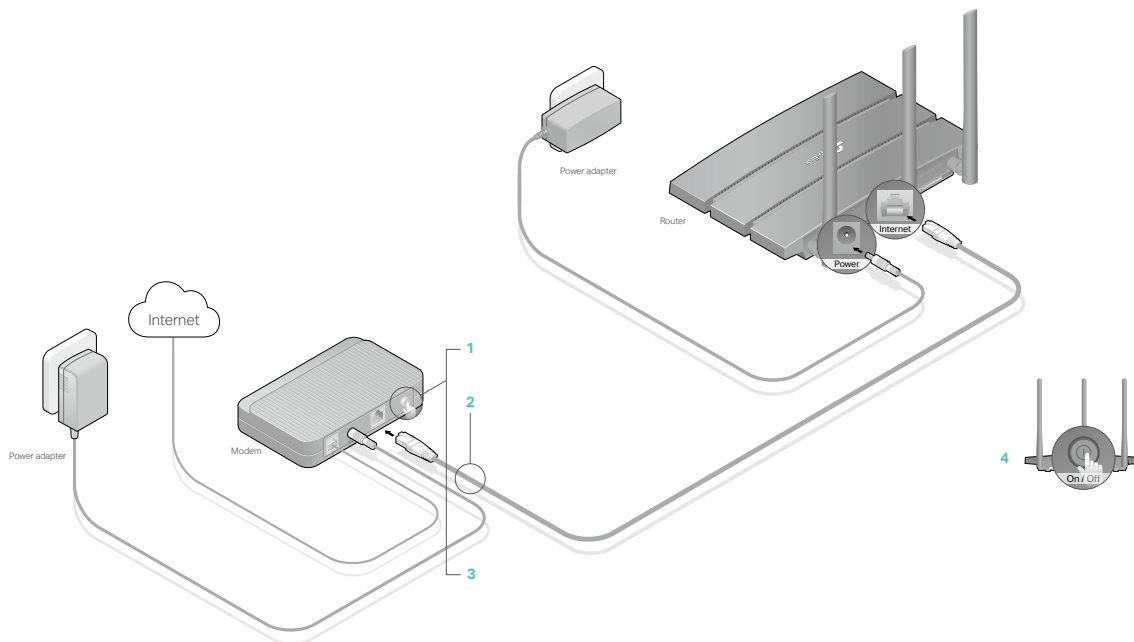

1. Turn off the modem, and remove the backup battery if it has one.
2. Connect the modem to your router's Internet port with an Ethernet cable.
3. Turn on the modem, and then wait about **2 minutes** for it to restart.
4. Connect the power adapter to the router and turn on the router.

5. Verify that the following LEDs are on and solid to confirm the hardware is connected correctly.



Note:

If the 2.4G LED and 5G LED are off, press and hold the WPS/Wi-Fi button on the back for more than 2 seconds. Both the LEDs should turn solid on.

6. Connect your computer to the router.

• **Method 1: Wired**

Turn off the Wi-Fi on your computer and connect the devices as shown below.

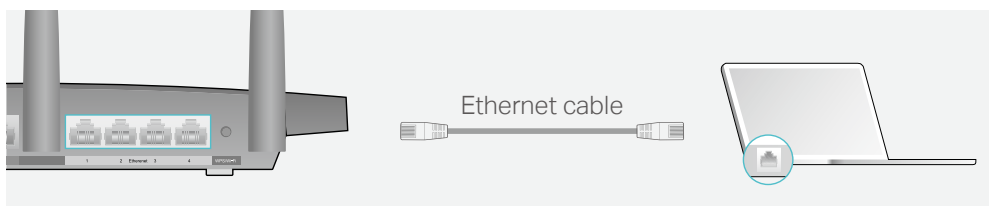

• **Method 2: Wirelessly**

- 1) Find the SSID (Network Name) and Wireless Password printed on the label at the bottom of the router.
- 2) Click the network icon of your computer or go to Wi-Fi Settings of your smart device, and then select the SSID to join the network.

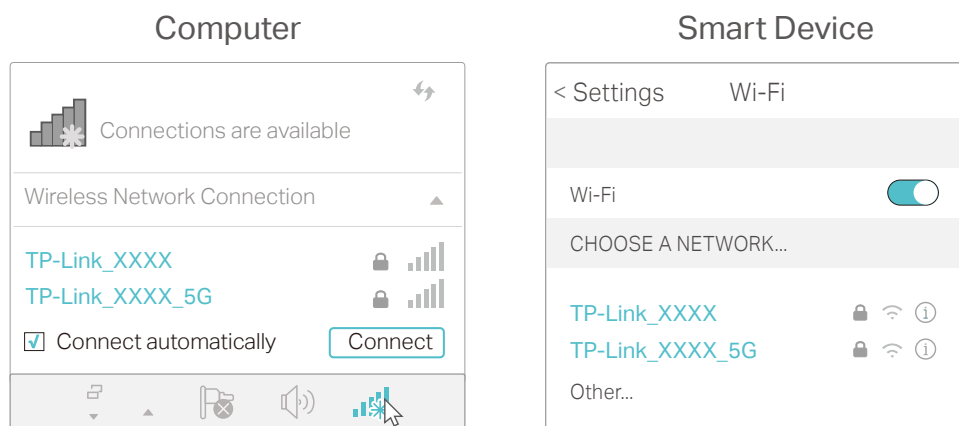

• **Method 3: Use the WPS button**

Wireless devices that support WPS, including Android phones, tablets, and most USB network cards, can be connected to your router through this method.

Note:

- WPS is not supported by iOS devices.
- The WPS function cannot be configured if the wireless function of the router is disabled. Also, the WPS function will be disabled if your wireless encryption is WEP. Please make sure the wireless function is enabled and is configured with the appropriate encryption before configuring the WPS.

- 1) Tap the WPS icon on the device's screen. Here we take an Android phone for instance.
- 2) Within two minutes, press the Reset/WPS button on your router.

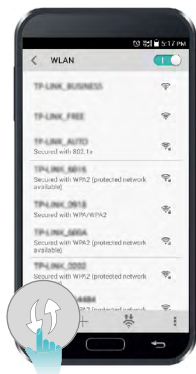

close to

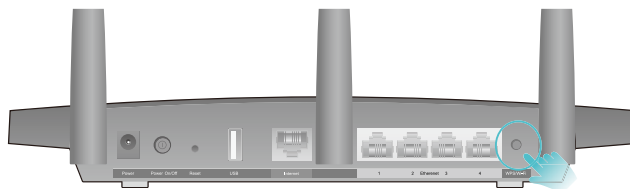

Chapter 3

Log In to Your Router

With a web-based utility, it is easy to configure and manage the router. The web-based utility can be used on any Windows, Mac OS or UNIX OS with a Web browser, such as Microsoft Internet Explorer, Mozilla Firefox or Apple Safari.

Follow the steps below to log in to your router.

1. Set up the TCP/IP Protocol in [Obtain an IP address automatically](#) mode on your computer.
2. Visit <http://tplinkwifi.net>, and create a login password for secure management purposes. Then click [Let's Get Started](#) to log in.

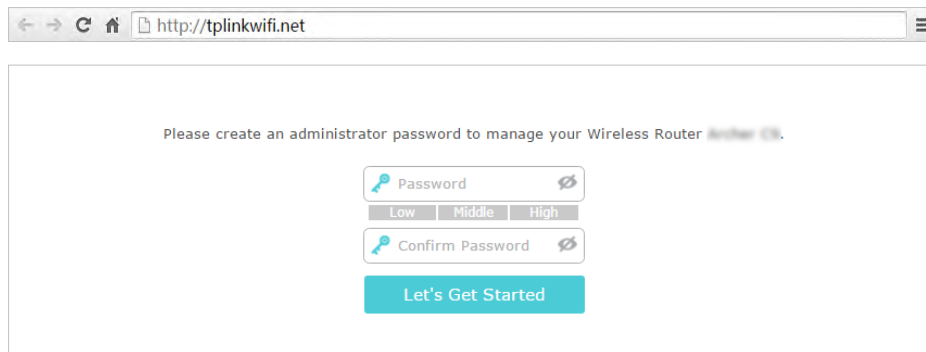

The screenshot shows a web browser window with the address bar displaying <http://tplinkwifi.net>. The main content area contains the following text and form elements:

Please create an administrator password to manage your Wireless Router Archer C60.

Below the text is a form with two password input fields:

- The first field is labeled "Password" and has a strength indicator below it with three buttons: "Low", "Middle", and "High".
- The second field is labeled "Confirm Password".

At the bottom of the form is a teal button labeled "Let's Get Started".

Note:

- If the login window does not appear, please refer to the [FAQ](#) Section.
- If you have registered a TP-Link ID and bound your cloud router to it, the login password you created here will be invalid. Please log in to the cloud router using your TP-Link ID.

Chapter 4

Set Up Internet Connection

This chapter introduces how to connect your router to the internet. The router is equipped with a web-based Quick Setup wizard. It has necessary ISP information built in, automates many of the steps and verifies that those steps have been successfully completed. Furthermore, you can also set up an IPv6 connection if your ISP provides IPv6 service.

It contains the following sections:

- [Use Quick Setup Wizard](#)
- [Manually Set up Your Internet Connection](#)
- [Set Up an IPv6 Internet Connection](#)
- [Configure the Router in Access Point Mode](#)

4.1. Use Quick Setup Wizard

The Quick Setup Wizard will guide you to set up your router.

☞ **Tips:**

If you need the IPv6 internet connection, please refer to the section of [Set Up an IPv6 Internet Connection](#).

Follow the steps below to set up your router.

1. Visit <http://tplinkwifi.net>, and log in with the password you set for the router.
2. Click **Quick Setup** on the top of the page. Then follow the step-by-step instructions to connect your router to the internet.
3. To enjoy a more complete service from TP-Link (remote management, TP-Link DDNS, etc.), log in with your TP-Link ID or click **Resigter Now** to get one. Then follow the instructions to bind the cloud router to your TP-Link ID.

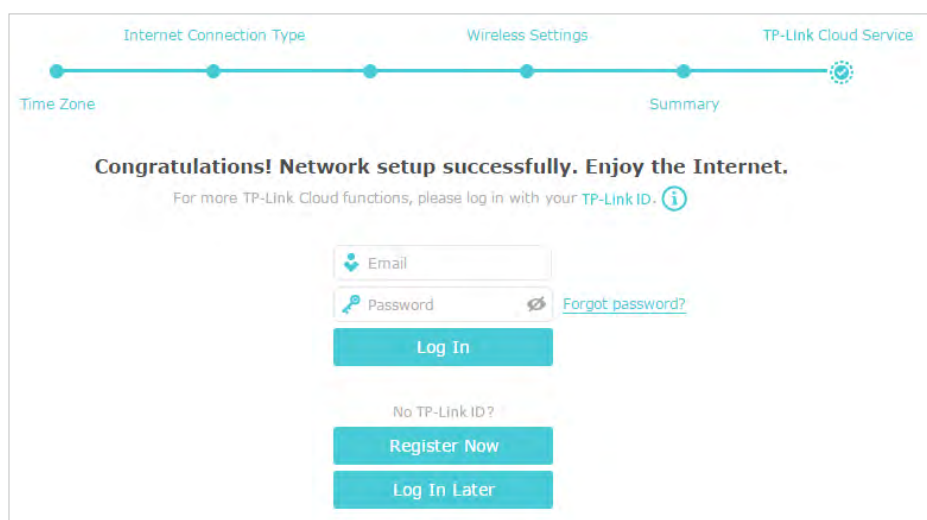

■ **Note:**

- To learn more about the TP-Link Cloud service, please refer to the [TP-Link Cloud Service](#) section.
- If you do not want to register a TP-Link ID now, you may click **Log In Later** to proceed.
- If you have changed the preset wireless network name (SSID) and wireless password during the Quick Setup process, all your wireless devices must use the new SSID and password to connect to the router.

4.2. Manually Set up Your Internet Connection

In this part, you can check your current internet connection settings. You can also modify the settings according to the service information provided by your ISP.

Follow the steps below to check or modify your internet connection settings.

1. Visit <http://tplinkwifi.net>, and log in with your TP-Link ID or the password you set for the router.
2. Go to **Basic > Internet**.
3. Select your internet connection type from the drop-down list.

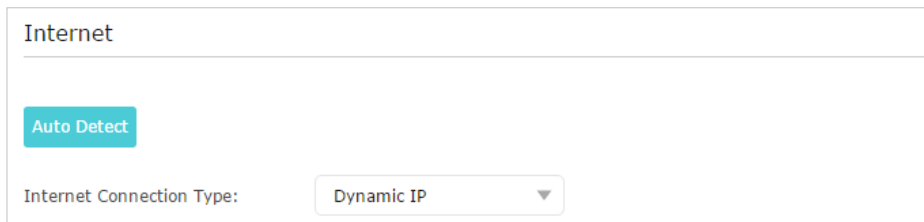

Internet

Auto Detect

Internet Connection Type: Dynamic IP

Note:

If you are unsure of what your connection type is, click [Auto Detect](#). Since different connection types require different cables and connection information, you can also refer to the demonstrations in Step 4 to determine your connection type.

4. Follow the instructions on the page to continue the configuration. Parameters on the figures are just used for demonstration.

- 1) If you choose [Dynamic IP](#), you need to select whether to clone the MAC address. Dynamic IP users are usually equipped with a cable TV or fiber cable.

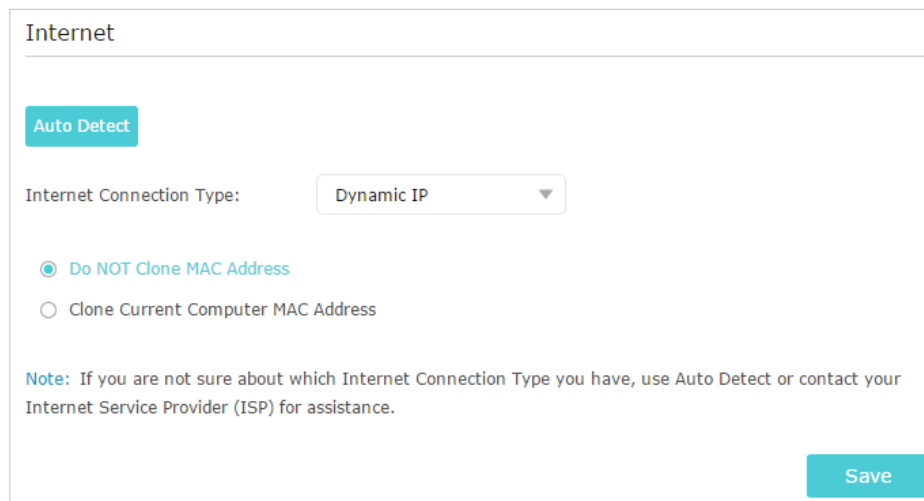

Internet

Auto Detect

Internet Connection Type: Dynamic IP

Do NOT Clone MAC Address

Clone Current Computer MAC Address

Note: If you are not sure about which Internet Connection Type you have, use Auto Detect or contact your Internet Service Provider (ISP) for assistance.

Save

- 2) If you choose [Static IP](#), enter the information provided by your ISP in the corresponding fields.

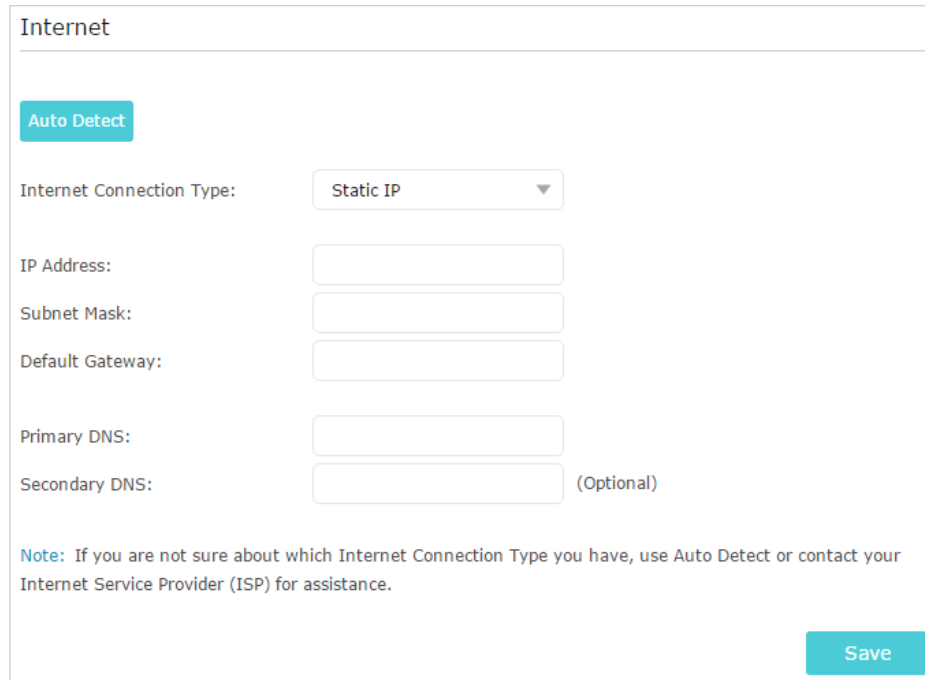

The screenshot shows the 'Internet' configuration page. At the top left is the title 'Internet'. Below it is a teal button labeled 'Auto Detect'. The 'Internet Connection Type:' dropdown menu is set to 'Static IP'. Below this are five input fields: 'IP Address:', 'Subnet Mask:', 'Default Gateway:', 'Primary DNS:', and 'Secondary DNS:'. The 'Secondary DNS:' field has '(Optional)' written to its right. At the bottom right is a teal 'Save' button. A note at the bottom reads: 'Note: If you are not sure about which Internet Connection Type you have, use Auto Detect or contact your Internet Service Provider (ISP) for assistance.'

- 3) If you choose **PPPoE**, enter the **username** and **password** provided by your ISP. PPPoE users usually have DSL cable modems.

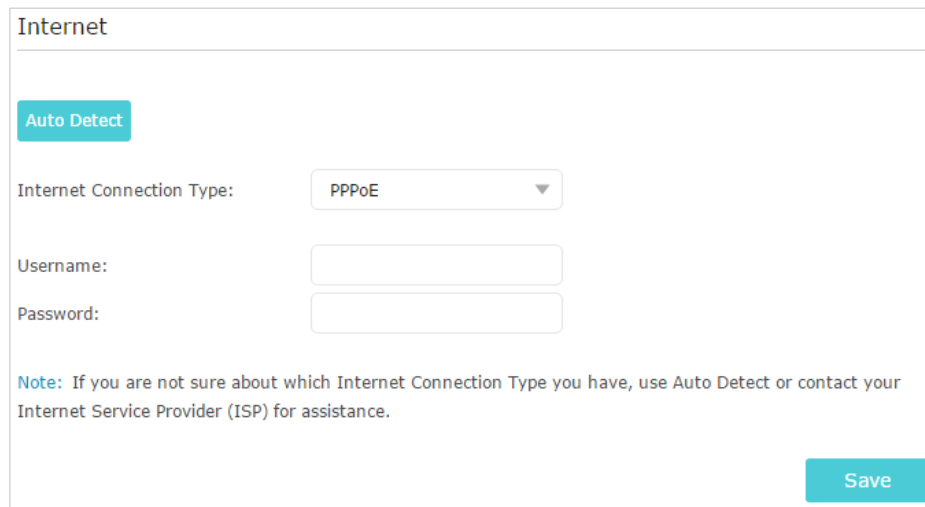

The screenshot shows the 'Internet' configuration page. At the top left is the title 'Internet'. Below it is a teal button labeled 'Auto Detect'. The 'Internet Connection Type:' dropdown menu is set to 'PPPoE'. Below this are two input fields: 'Username:' and 'Password:'. At the bottom right is a teal 'Save' button. A note at the bottom reads: 'Note: If you are not sure about which Internet Connection Type you have, use Auto Detect or contact your Internet Service Provider (ISP) for assistance.'

- 4) If you choose **L2TP**, enter the **username** and **password** and choose the **Secondary Connection** provided by your ISP. Different parameters are needed according to the Secondary Connection you have chosen.

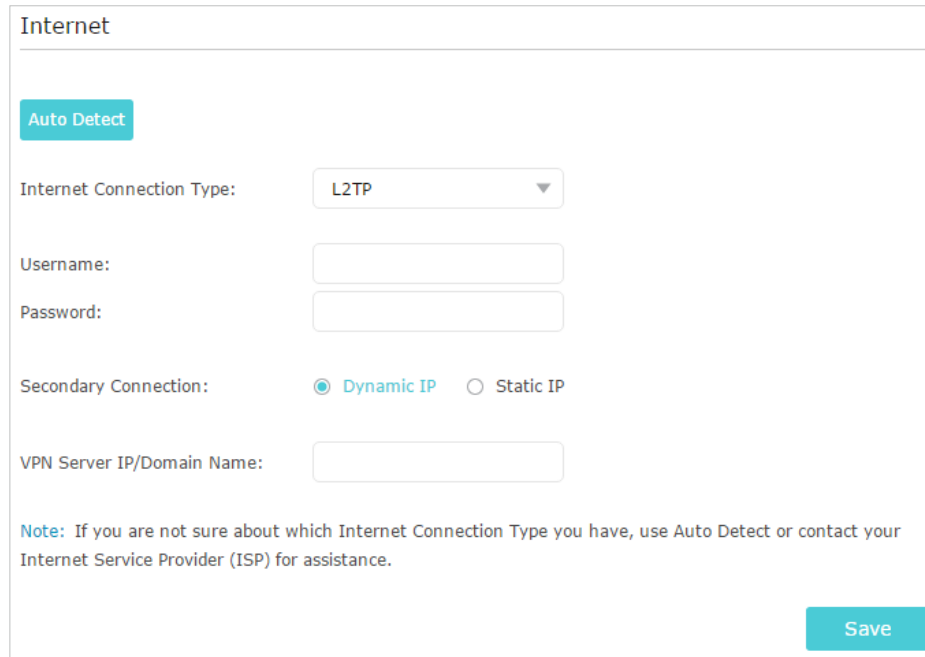

The screenshot shows the 'Internet' configuration page. At the top left, there is a teal button labeled 'Auto Detect'. Below it, the 'Internet Connection Type:' dropdown menu is set to 'L2TP'. There are empty input fields for 'Username:' and 'Password:'. Under 'Secondary Connection:', the 'Dynamic IP' radio button is selected, and the 'Static IP' radio button is unselected. There is an empty input field for 'VPN Server IP/Domain Name:'. A blue note at the bottom states: 'Note: If you are not sure about which Internet Connection Type you have, use Auto Detect or contact your Internet Service Provider (ISP) for assistance.' A teal 'Save' button is located at the bottom right.

- 5) If you choose **PPTP**, enter the **username** and **password**, and choose the **Secondary Connection** provided by your ISP. Different parameters are needed according to the Secondary Connection you have chosen.

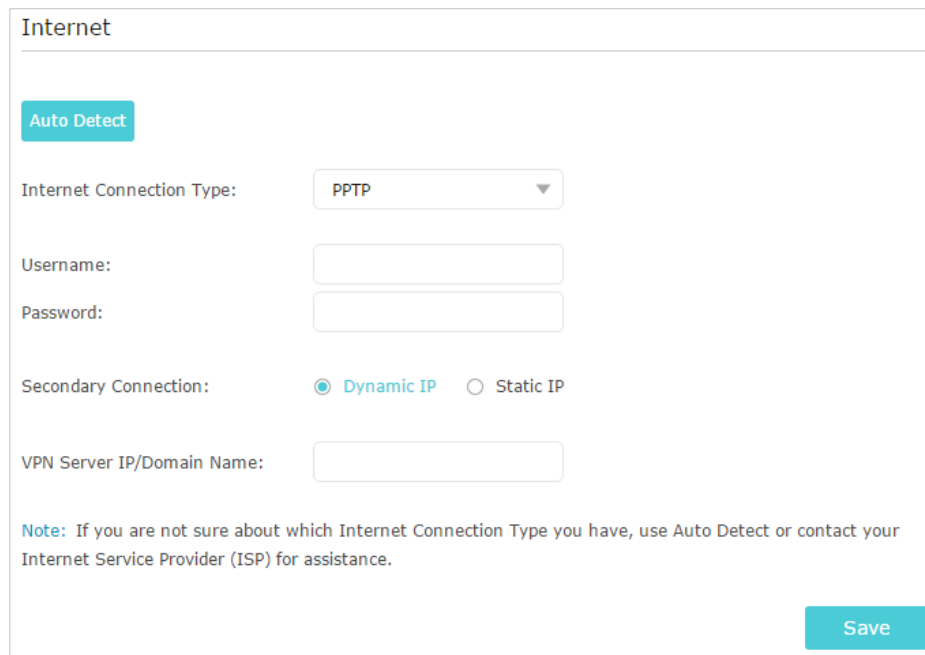

The screenshot shows the 'Internet' configuration page. At the top left, there is a teal button labeled 'Auto Detect'. Below it, the 'Internet Connection Type:' dropdown menu is set to 'PPTP'. There are empty input fields for 'Username:' and 'Password:'. Under 'Secondary Connection:', the 'Dynamic IP' radio button is selected, and the 'Static IP' radio button is unselected. There is an empty input field for 'VPN Server IP/Domain Name:'. A blue note at the bottom states: 'Note: If you are not sure about which Internet Connection Type you have, use Auto Detect or contact your Internet Service Provider (ISP) for assistance.' A teal 'Save' button is located at the bottom right.

5. Click **Save**.
6. To check your internet connection, click **Network Map** on the left of the page. After the connection succeeds, the screen will display as follows. Here we take PPPoE as an example.

Note:

It may take 1-2 minutes to make the settings valid.

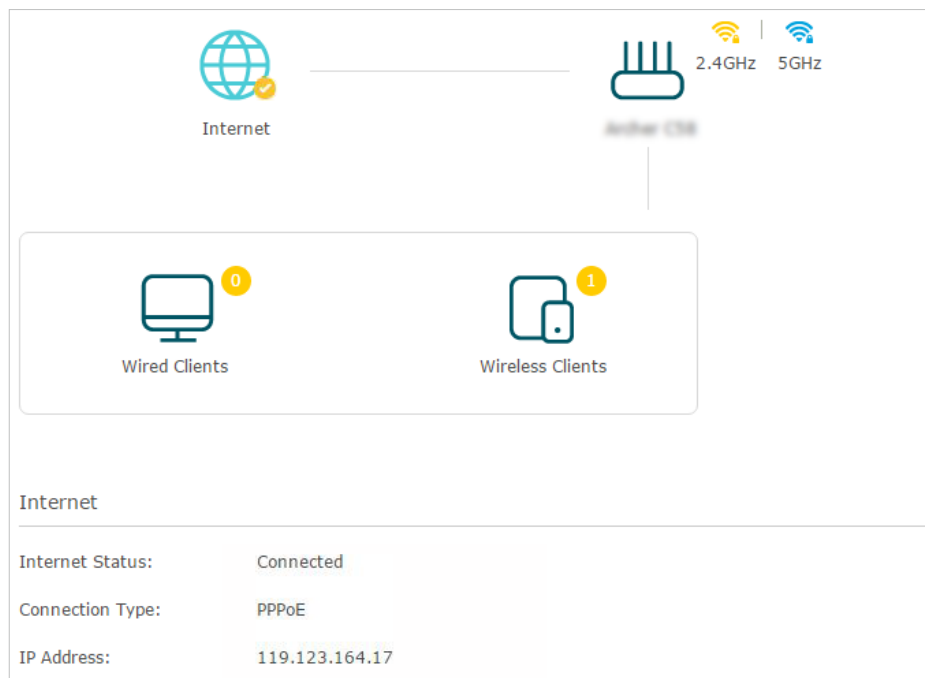
**Tips:**

- If your internet connection type is [BigPond Cable](#), please go to [Advanced > Network > Internet](#) to set your router.
- If you use [Dynamic IP](#) and [PPPoE](#) and you are provided with any other parameters that are not required on the page, please go to [Advanced > Network > Internet](#) to complete the configuration.
- If you still cannot access the internet, refer to the [FAQ](#) section for further instructions.

4.3. Set Up an IPv6 Internet Connection

Your ISP provides information about one of the following IPv6 internet connection types: PPPoE, Dynamic IP(SLAAC/DHCPv6), Static IP, 6to4 tunnel, Pass-Through (Bridge).

1. Visit <http://tplinkwifi.net>, and log in with your TP-Link ID or the password you set for the router.
2. Go to [Advanced > IPv6](#).
3. Enable IPv6 and select the internet connection type provided by your ISP.

Tips:

If you do not know what your internet connection type is, contact your ISP or judge according to the already known information provided by your ISP.

4. Fill in information as required by different connection types. Red blanks must be filled in.

- 1) **Static IP:** Fill in blanks and click [Save](#).

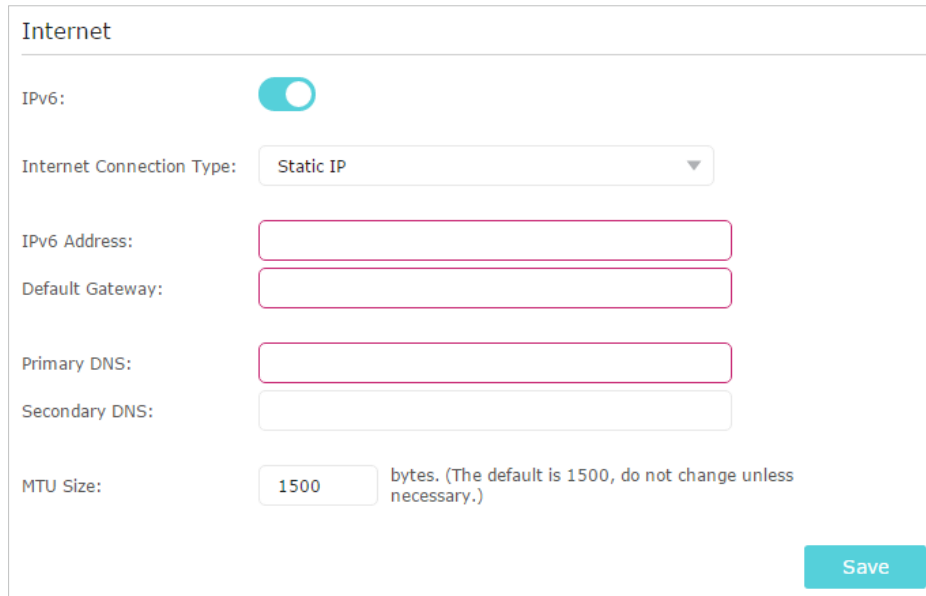

The screenshot shows the 'Internet' configuration page. At the top, the title 'Internet' is displayed. Below it, there is a toggle switch for 'IPv6' which is turned on. The 'Internet Connection Type' is set to 'Static IP' in a dropdown menu. There are four empty text input fields for 'IPv6 Address:', 'Default Gateway:', 'Primary DNS:', and 'Secondary DNS:'. The 'MTU Size' is set to '1500' bytes, with a note that says '(The default is 1500, do not change unless necessary.)'. A 'Save' button is located at the bottom right of the form.

- 2) **Dynamic IP(SLAAC/DHCPv6):** Click [Advanced](#) to input further information if your ISP requires. Click [Save](#) and then click [Renew](#).

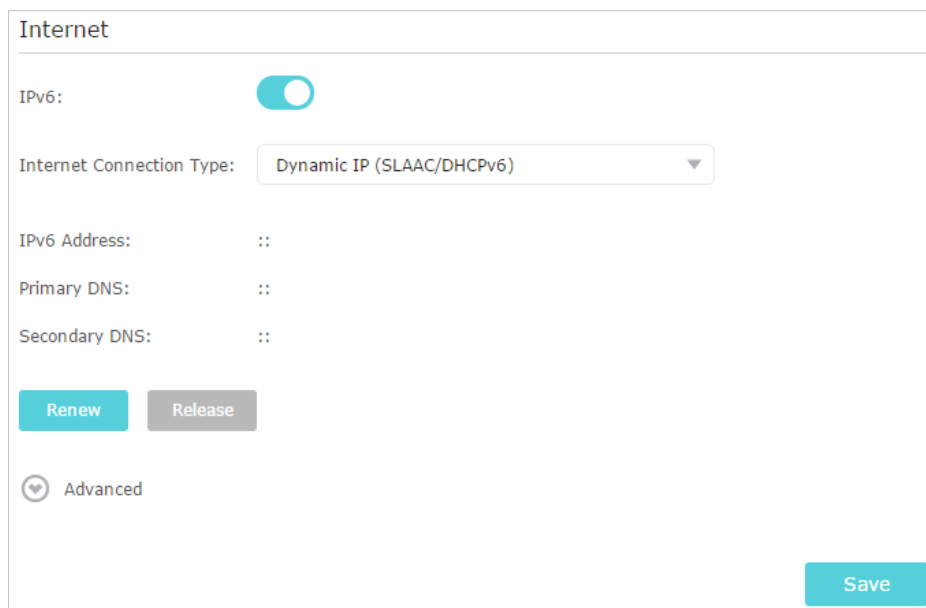

The screenshot shows the 'Internet' configuration page. At the top, the title 'Internet' is displayed. Below it, there is a toggle switch for 'IPv6' which is turned on. The 'Internet Connection Type' is set to 'Dynamic IP (SLAAC/DHCPv6)' in a dropdown menu. The 'IPv6 Address:', 'Primary DNS:', and 'Secondary DNS:' fields are all set to '::'. There are two buttons: 'Renew' (highlighted in blue) and 'Release' (grey). Below these buttons is a checkbox labeled 'Advanced' which is checked. A 'Save' button is located at the bottom right of the form.

- 3) **PPPoE:** By default, the router uses the IPv4 account to connect to the IPv6 server. Click [Advanced](#) to input further information if your ISP requires. Click [Save](#) and then click [Connect](#).

Note:

If your ISP provides two separate accounts for the IPv4 and IPv6 connections, please untick the [Use the same session with IPv4 connection](#) checkbox and manually enter the username and password for the IPv6 connection.

The screenshot shows the 'Internet' settings panel. At the top, the title 'Internet' is displayed. Below it, the 'IPv6' toggle is turned on. The 'Internet Connection Type' dropdown menu is set to 'PPPoE'. A checkbox labeled 'PPPoE same session with IPv4 connection' is checked. The 'IPv6 Address' field contains '::'. There is an 'Advanced' section with a downward arrow icon. At the bottom, there are 'Connect' and 'Disconnect' buttons, and a 'Save' button in the bottom right corner.

- 4) **6to4 Tunnel:** An IPv4 internet connection type is a prerequisite for this connection type ([Manually Set up Your Internet Connection](#)). Click **Advanced** to input further information if your ISP requires. Click **Save** and then click **Connect**.

The screenshot shows the 'Internet' settings panel. At the top, the title 'Internet' is displayed. Below it, the 'IPv6' toggle is turned on. The 'Internet Connection Type' dropdown menu is set to '6to4 Tunnel'. The 'IPv4 Address', 'IPv4 Subnet Mask', and 'IPv4 Default Gateway' fields all contain '0.0.0.0'. The 'TUNNEL ADDRESS' field contains '::'. There is an 'Advanced' section with a downward arrow icon. At the bottom, there are 'Connect' and 'Disconnect' buttons, and a 'Save' button in the bottom right corner.

- 5) **Pass-Through (Bridge):** Click **Save** and skip to step 6.

The screenshot shows the 'Internet' settings panel. At the top, the title 'Internet' is displayed. Below it, the 'IPv6' toggle is turned on. The 'Internet Connection Type' dropdown menu is set to 'Pass-Through (Bridge)'. A 'Save' button is located in the bottom right corner.

- Configure LAN ports. Windows users are recommended to choose from the first two types. Fill in [Address Prefix](#) provided by your ISP, and click [Save](#).

Tips:

Find [Help](#) on the management interface to know more about items.

LAN

Assigned Type: DHCPv6 SLAAC+Stateless DHCP SLAAC+RDNSS

Address Prefix: /64

Address: ::/0

[Save](#)

- Click [Status](#) to check whether you have successfully set up an IPv6 connection. The following figure is an example of a successful PPPoE configuration.



Tips:

Visit the [FAQ](#) section if there is no internet connection.

4.4. Configure the Router in Access Point Mode

In this mode, your router connects to a wired or wireless router via an Ethernet cable and extends the wireless coverage of your existing network. Advanced functions like NAT, Parental Controls and QoS are not supported in this mode.

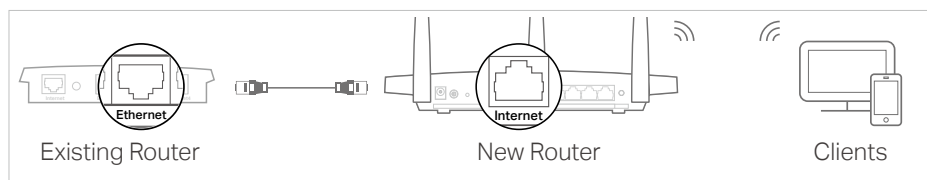

- Connect the router's **Internet** port to the existing router's **Ethernet** port via an Ethernet cable.

2. Visit <http://tplinkwifi.net>, and log in with your TP-Link ID or the password you set for the router.
3. Go to **Advanced > Operation Mode**, select **Access Point** and click **Save**. Log in to the router via <http://tplinkwifi.net> after the router reboots.
4. Go to **Quick Setup** or **Settings > Wireless > Wireless Settings** and set the SSIDs and passwords for the wireless network.

Now, you can connect to the SSIDs and enjoy your existing network.

Chapter 5

TP-Link Cloud Service

TP-Link Cloud service provides a better way to manage your cloud devices. Log in to your router with a TP-Link ID, and you can easily monitor and manage your home network when you are out and about via the Tether app. To ensure that your router stays new and gets better over time, the TP-Link Cloud will notify you when an important firmware upgrade is available. Surely you can also manage multiple TP-Link Cloud devices with a single TP-Link ID.

This chapter introduces how to register a new TP-Link ID, bind or unbind TP-Link IDs to manage your router, and the Tether app with which you can manage your home network no matter where you may find yourself.

It contains the following sections:

- [Register a TP-Link ID](#)
- [Change Your TP-Link ID Information](#)
- [Manage the User TP-Link IDs](#)
- [Manage the Router via the TP-Link Tether App](#)

5.1. Register a TP-Link ID

If you have skipped the registration during the Quick Setup process, you can:

1. Visit <http://tplinkwifi.net>, and log in with the password you set for the router.
2. Go to [Basic > TP-Link Cloud](#).
3. Click [Register Now](#) and follow the instructions to register a TP-Link ID.

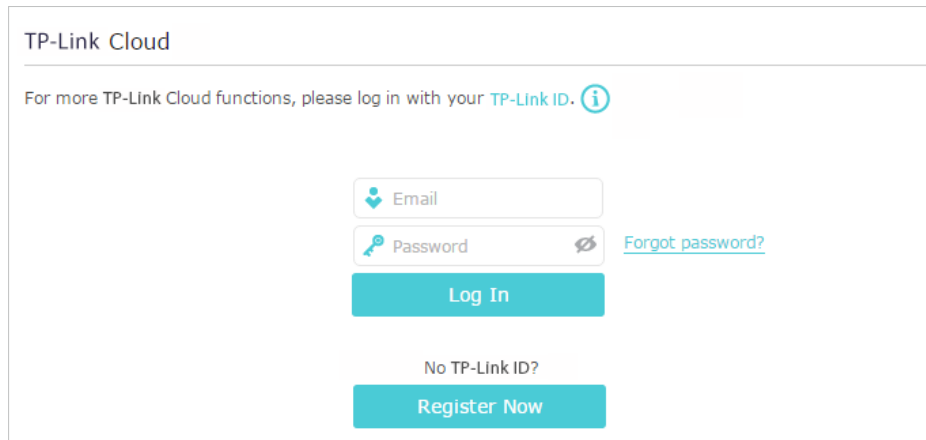

TP-Link Cloud

For more TP-Link Cloud functions, please log in with your TP-Link ID. [i](#)

Email

Password [Forgot password?](#)

Log In

No TP-Link ID?

Register Now

4. After activating your TP-Link ID, come back to the TP-Link Cloud page to log in. The first-time login TP-Link ID will be bound automatically to your cloud router as an [Admin](#).

■ Note:

- To learn more about the Admin and User TP-Link ID, refer to [Manage the User TP-Link IDs](#).
- Once the router is bound to your TP-Link ID, you need to log in to the router with the TP-Link ID.
- You can register another TP-Link ID via the Tether APP. Please refer to [Manage the Router via the TP-Link Tether App](#) to install the app and register a new one
- If you want to unbind the admin TP-Link ID from your router, please go to [Basic > TP-Link Cloud](#), click [Unbind](#) in the Device Information section.

5.2. Change Your TP-Link ID Information

Follow the steps below to modify your TP-Link ID as needed.

1. Visit <http://tplinkwifi.net>, and log in with your TP-Link ID.
2. Go to [Basic > TP-Link Cloud](#), and focus on the [Account Information](#) section.

- **To change your email address**

1. Click  behind the Email.
2. Enter the password of your TP-Link ID, then a new email address. And click [Save](#).

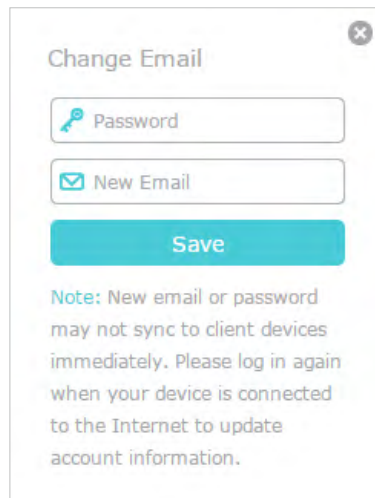

The 'Change Email' dialog box features a title bar with a close button (X). It contains two input fields: 'Password' with a key icon and 'New Email' with an envelope icon. Below these is a teal 'Save' button. A note at the bottom states: 'Note: New email or password may not sync to client devices immediately. Please log in again when your device is connected to the Internet to update account information.'

- **To change your password**

1. Click  behind the Password.
2. Enter the current password, then a new password twice. And click [Save](#).

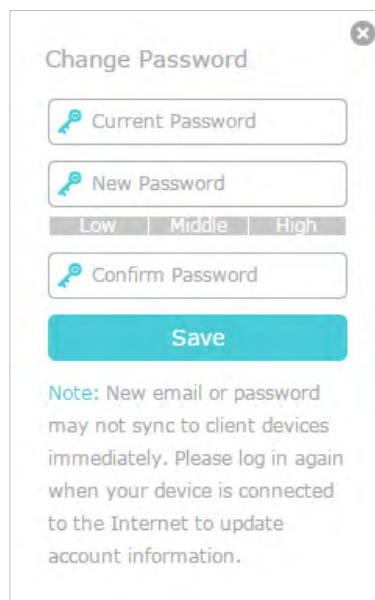

The 'Change Password' dialog box features a title bar with a close button (X). It contains three input fields: 'Current Password', 'New Password', and 'Confirm Password', each with a key icon. The 'New Password' field has a strength indicator below it with 'Low', 'Middle', and 'High' levels. Below these is a teal 'Save' button. A note at the bottom states: 'Note: New email or password may not sync to client devices immediately. Please log in again when your device is connected to the Internet to update account information.'

5.3. Manage the User TP-Link IDs

The first-time login TP-Link ID will be bound automatically to your router as an [Admin](#) account. An admin account can add or remove other TP-Link IDs to the same router as [Users](#). The admin account and User accounts both can monitor and manage the router locally or remotely, but user accounts cannot:

- Reset the router to its factory default settings either on the web management page or in the Tether app.

- Add/remove other TP-Link IDs to/from the router.

5.3.1. Add TP-Link ID to Manage the Router

1. Visit <http://tplinkwifi.net>, and log in with your TP-Link ID.
2. Go to **Basic** > **TP-Link Cloud**, and focus on the **Bound Accounts** section.
3. Click **+ Bind**, enter another TP-Link ID as needed and click **Save**.

Note:

If you need another TP-Link ID, please refer to [Manage the Router via the TP-Link Tether App](#) to install the app and register a new one.

4. The new TP-Link ID will be displayed in the Bound Accounts table as a **User**.

Bound Accounts				
+ Bind - Unbind				
<input type="checkbox"/>	ID	Email	Binding Date	Role
<input type="checkbox"/>	1	*****@****.com	16/11/2016	Admin
<input type="checkbox"/>	2	*****@****.com	16/11/2016	User

5.3.2. Remove TP-Link ID(s) from Managing the Router

1. Visit <http://tplinkwifi.net>, and log in with your TP-Link ID.
2. Go to **Basic** > **TP-Link Cloud**, and focus on the **Bound Accounts** section.
3. Tick the checkbox(es) of the TP-Link ID(s) you want to remove and click **Unbind**.

Bound Accounts				
+ Bind - Unbind				
<input type="checkbox"/>	ID	Email	Binding Date	Role
<input type="checkbox"/>	1	*****@****.com	16/11/2016	Admin
<input checked="" type="checkbox"/>	2	*****@****.com	16/11/2016	User

5.4. Manage the Router via the TP-Link Tether App

The Tether app runs on iOS and Android devices like smartphones and tablets.

1. Open the Apple App Store or Google Play and search the key word "TP-Link Tether" or simply scan the QR code to download and install the app.



2. Connect your device to the router's wireless network.
3. Launch the Tether app, select the model of your router and log in with your TP-Link ID or the password you set for the router.
4. Manage your router as needed.

Chapter 6

Work with Alexa and IFTTT

This chapter will show you how to configure your router to work with Alexa and IFTTT.

Control your network devices using simply the power of your voice with the TP-Link Router Skill for Amazon. Prioritize the Internet connection of your laptop, switch off your router's LED or ask Alexa to read out the password of the guest network, all without stopping what you're doing.

With IFTTT, you can trigger actions when devices are connecting, disconnecting, or being added to your network. You can even choose to prioritize certain devices every time you use them.

1. Visit <http://tplinkwifi.net>, and log in with your TP-Link ID or the password you set for the router.
2. Go to **Advanced** > **Smart Life Assistant**.
3. Follow the on-screen instructions on the **Alexa** or **IFTTT** section to set up smart control of your router.

Or download **TP-Link Tether** app, open it and tap the  icon, then select **Smart Life Assistants** to complete the setup.

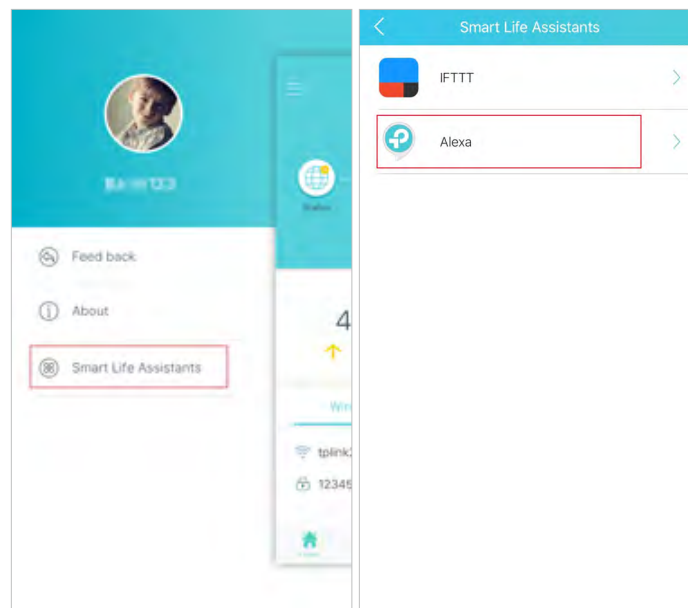



Chapter 7

OneMesh with Seamless Roaming

This chapter introduces the TP-Link OneMesh™ feature.

It contains the following sections:

- [Set Up a OneMesh Network](#)
- [Manage Devices in the OneMesh Network](#)

TP-Link OneMesh  router and TP-Link OneMesh  extenders work together to form one unified Wi-Fi network. Walk through your home and stay connected with the fastest possible speeds thanks to OneMesh's seamless coverage.

Unified Wi-Fi Network

Router and extenders share the same wireless settings, including network name, password, access control settings and more.

Seamless Roaming

Devices automatically switch between your router and extenders as you move through your home for the fastest possible speeds.

Easy Setup and Management

Set up a OneMesh network with a push of WPS buttons. Manage all network devices on the Tether app or at your router's web management page.

Unified OneMesh Network

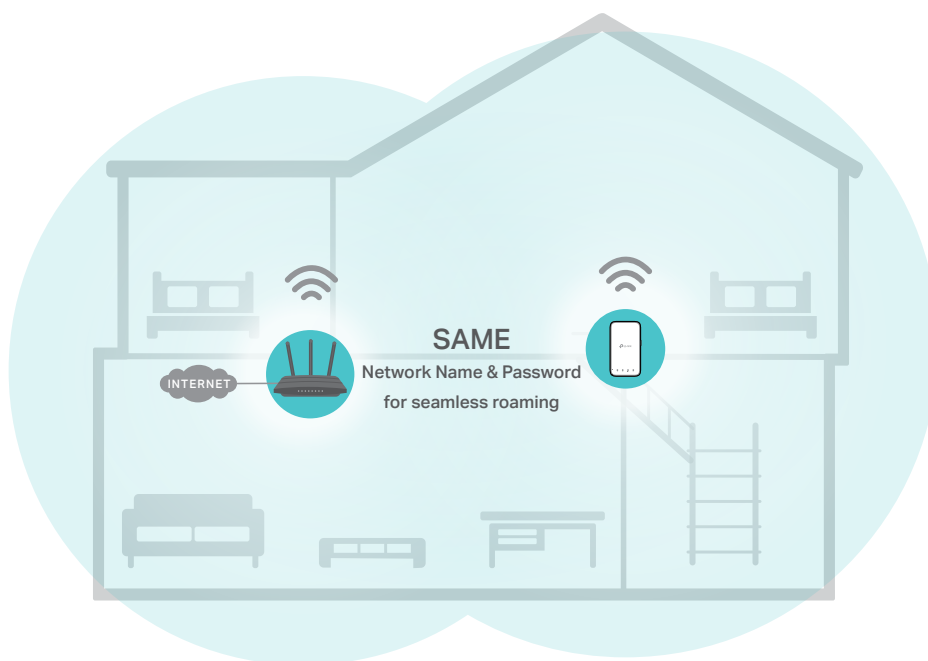

7.1. Set Up a OneMesh Network

1. Visit <http://tplinkwifi.net>, and log in with your TP-Link ID or the password you set for the router.
2. Go to **Basic > OneMesh** or **Advanced > Wireless > OneMesh**.

Note:

Early firmware versions may not support OneMesh. If you can't find the OneMesh page, please upgrade your router to the latest firmware version. For upgrade instructions, refer to [Upgrade the Firmware](#).

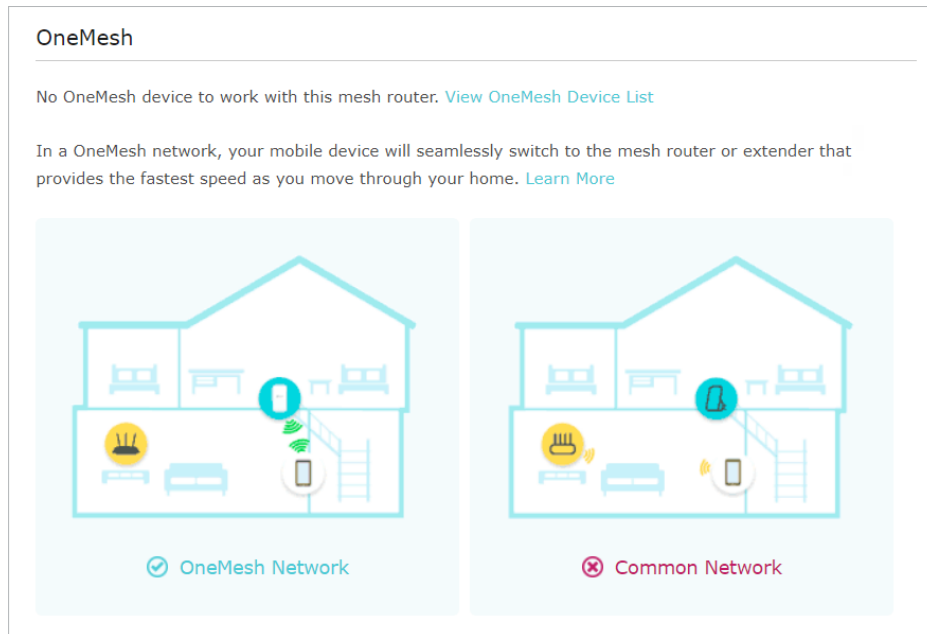

3. Connect one or more OneMesh extenders to this router by following the setup instructions in the extenders' manuals.

Note:

To check full list of TP-Link OneMesh devices, visit <https://www.tp-link.com/onemesh/compatibility>.

4. If you have set up an extender to join the OneMesh network, it will be listed in the [Devices in OneMesh Network](#) list. Otherwise, you need to find it in the [Available OneMesh Devices](#) list and click [Add](#) to add it to the OneMesh network.

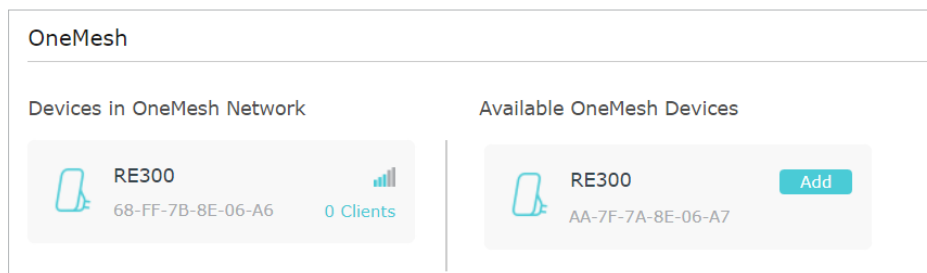

Now your router and extenders successfully form one OneMesh network!

7.2. Manage Devices in the OneMesh Network

In a OneMesh network, you can manage all mesh devices and clients on your router's web page.

- **To view all mesh devices and clients in the OneMesh network:**

1. Visit <http://tplinkwifi.net>, and log in with your TP-Link ID or the password you set for the router.
2. Go to [Basic > Network Map](#).
3. Click the [Mesh Devices](#), [Wired Clients](#), or [Wireless Clients](#) icon to view the related device or client list.

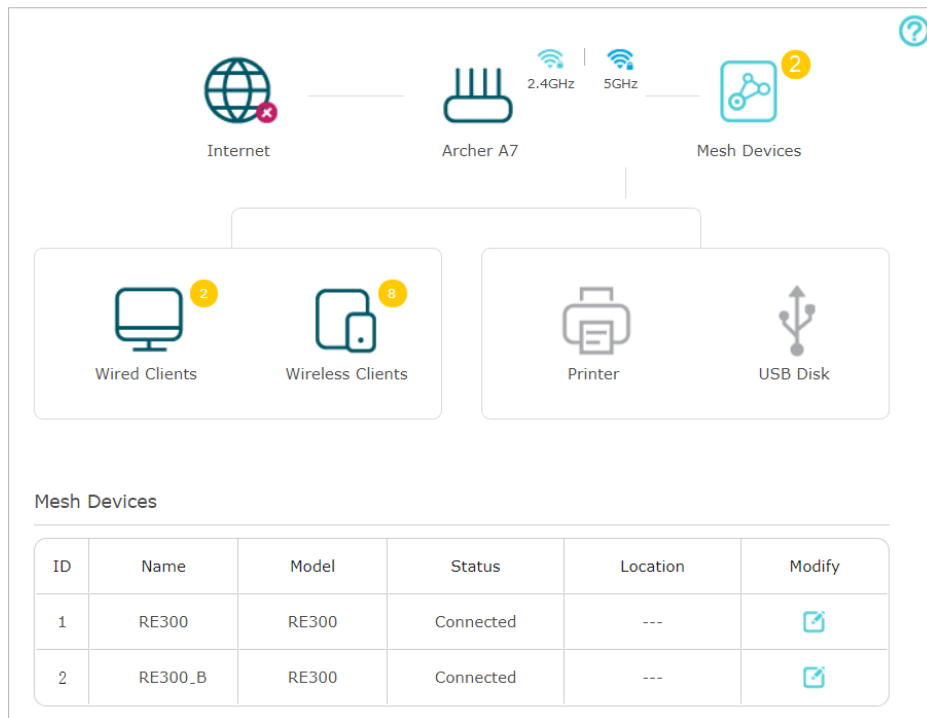

- **To manage each OneMesh device in the network:**

1. Visit <http://tplinkwifi.net>, and log in with your TP-Link ID or the password you set for the router.
2. Go to [Basic > OneMesh](#) or [Advanced > Wireless > OneMesh](#).

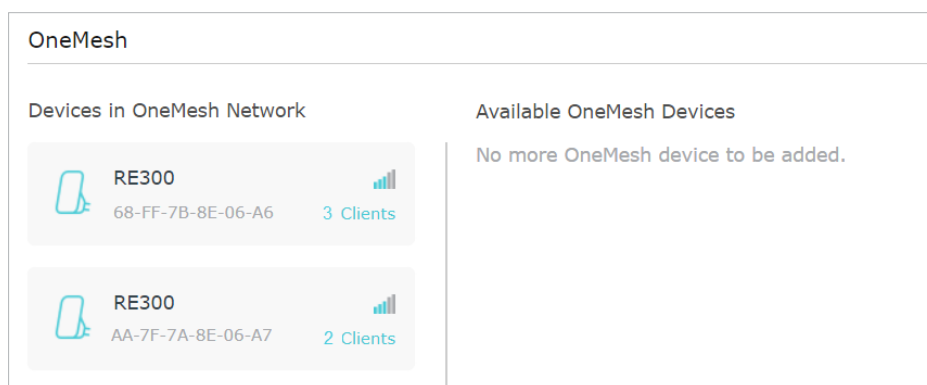

3. Click a OneMesh device to view the device information, or click [<number> Clients](#) to view the clients connected to this device.

On the [Device Info](#) page, you can:

- Click [Manage Device](#) to redirect to the web management page of this OneMesh device.
- Click [Leave OneMesh](#) to delete this device from the OneMesh network.

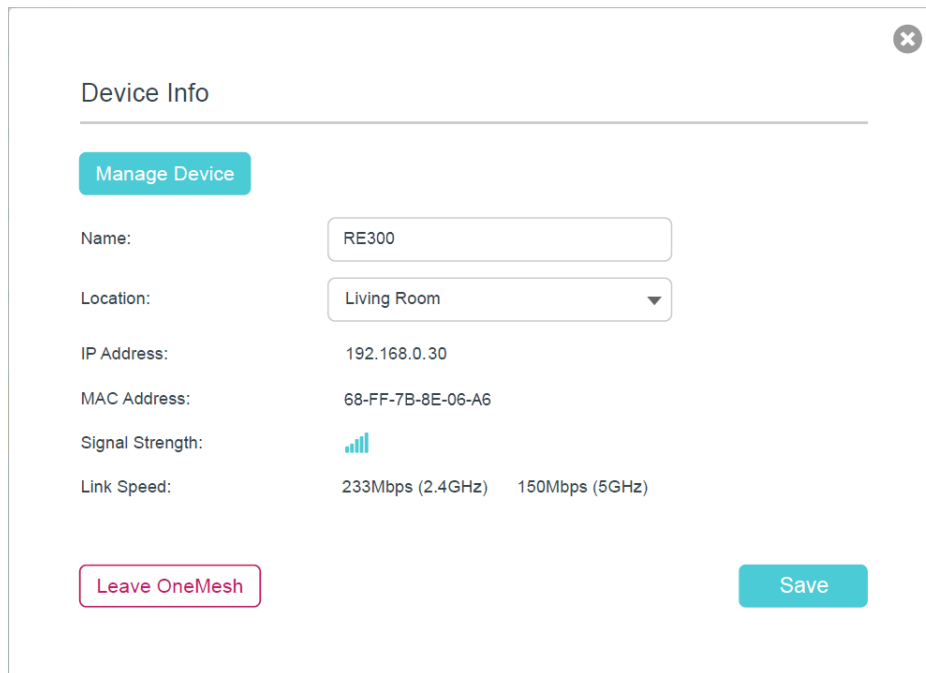

Device Info

[Manage Device](#)

Name: RE300

Location: Living Room

IP Address: 192.168.0.30

MAC Address: 68-FF-7B-8E-06-A6

Signal Strength: 

Link Speed: 233Mbps (2.4GHz) 150Mbps (5GHz)

[Leave OneMesh](#) [Save](#)

Chapter 8

Guest Network

This function allows you to provide Wi-Fi access for guests without disclosing your main network. When you have guests in your house, apartment, or workplace, you can create a guest network for them. In addition, you can customize guest network options to ensure network security and privacy.

It contains the following sections:

- [Create a Network for Guests](#)
- [Customize Guest Network Options](#)

8.1. Create a Network for Guests

1. Visit <http://tplinkwifi.net>, and log in with your TP-Link ID or the password you set for the router.
2. Go to [Advanced](#) > [Guest Network](#). Locate the [Wireless](#) section.
3. Create a guest network as needed.
 - 1) Select [2.4GHz](#) or [5GHz](#) network and tick the [Enable Guest Network](#) checkbox.
 - 2) Customize the SSID. Don't select [Hide SSID](#) unless you want your guests to manually input the SSID for guest network access.
 - 3) Set [Security](#) to [WPA/WPA2 Personal](#), keep the default [Version](#) and [Encryption](#) values, and customize your own password.

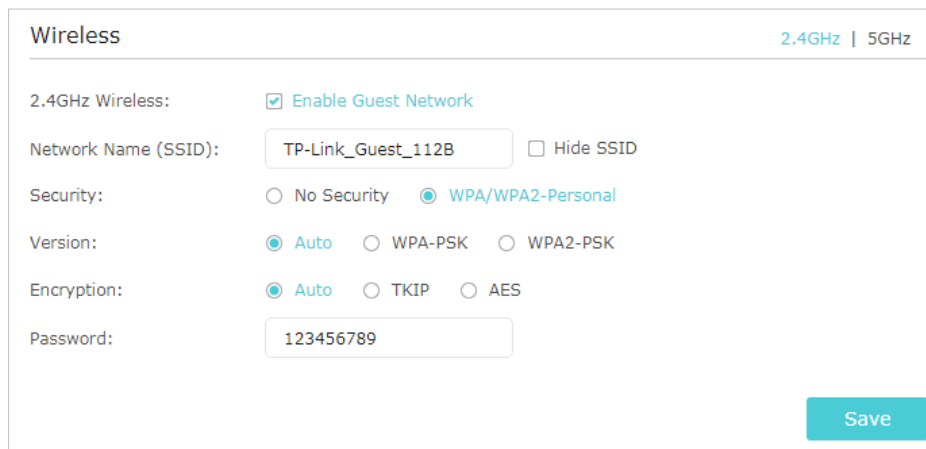

Wireless 2.4GHz | 5GHz

2.4GHz Wireless: [Enable Guest Network](#)

Network Name (SSID): [Hide SSID](#)

Security: No Security [WPA/WPA2-Personal](#)

Version: [Auto](#) WPA-PSK WPA2-PSK

Encryption: [Auto](#) TKIP AES

Password:

[Save](#)

4. Click [Save](#). Now your guests can access your guest network using the SSID and password you set!

Tips:

To view guest network information, go to [Advanced](#) > [Status](#) and locate the [Guest Network](#) section.

8.2. Customize Guest Network Options

1. Visit <http://tplinkwifi.net>, and log in with your TP-Link ID or the password you set for the router.
2. Go to [Advanced](#) > [Guest Network](#). Locate the [Settings](#) section.
3. Customize guest network options according to your needs.

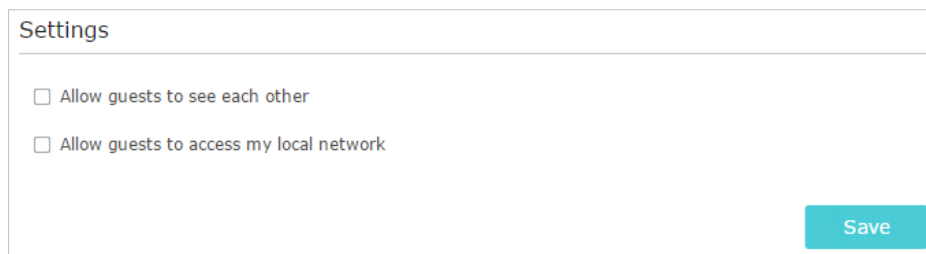

Settings

Allow guests to see each other

Allow guests to access my local network

Save

- [Allow guests to see each other](#)

Tick this checkbox if you want to allow the wireless clients on your guest network to communicate with each other via methods such as network neighbors and Ping.

- [Allow guests to access my local network](#)

Tick this checkbox if you want to allow the wireless clients on your guest network to communicate with the devices connected to your router's LAN ports or main network via methods such as network neighbors and Ping.

4. Click [Save](#). Now you can ensure network security and privacy!

 **Tips:**

To view guest network information, go to [Advanced](#) > [Status](#) and locate the [Guest Network](#) section.

Chapter 9

USB Settings

This chapter describes how to use the USB port to share files and media from the USB storage devices over your home network locally, or remotely through the internet.

The router supports USB external flash drives and hard drives.

It contains the following sections:

- [Access the USB Storage Device](#)
- [Media Sharing](#)
- [Offline Download](#)

9. 1. Access the USB Storage Device

Insert your USB storage device into the router's USB port and then access files stored there locally or remotely.

🔗 Tips:

- If you use USB hubs, make sure no more than 4 devices are connected to the router.
- If the USB storage device requires using bundled external power, make sure the external power has been connected.
- If you use a USB hard drive, make sure its file system is FAT32 or NTFS.
- Before you physically disconnect a USB device from the router, safely remove it to avoid data damage: Go to [Advanced > USB Settings > Device Settings](#) and click [Safely Remove](#).

9. 1. 1. Access the USB Device Locally

Insert your USB storage device into the router's USB port and then refer to the following table to access files stored on your USB storage device.

Windows computer

- **Method 1:**

Go to [Computer > Network](#), then click the Network Server Name ([TP-SHARE](#) by default) in the [Computer](#) section.

■ Note:

Operations in different systems are similar. Here we take Windows 7 as an example.

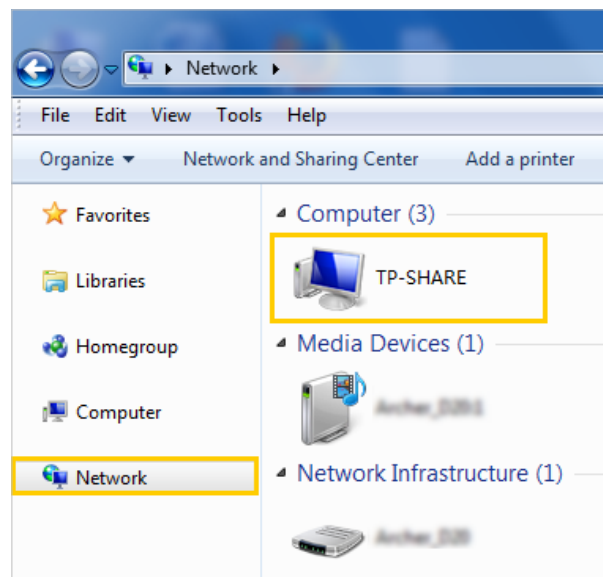

Windows
computer

- **Method 2:**

Open the [Windows Explorer](#) (or go to [Computer](#)) and type the server address `\\tplinkwifi.net` or `ftp://tplinkwifi.net` in the address bar, then press [Enter](#).

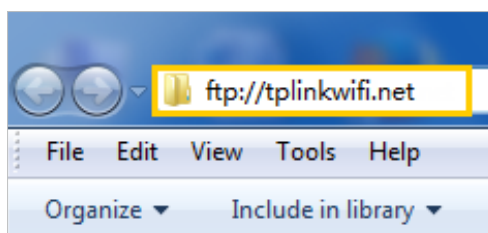

Mac

- 1) Select [Go > Connect to Server](#).
- 2) Type the server address `smb://tplinkwifi.net`.
- 3) Click [Connect](#).

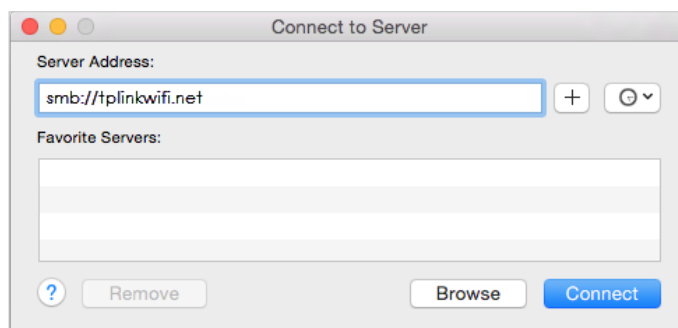

- 4) When prompted, select the [Guest](#) radio box. (If you have set up a username and a password to deny anonymous access to the USB disks, you should select the [Registered User](#) radio box. To learn how to set up an account for the access, refer to [To Set up Authentication for Data Security](#).)

Tablet

Use a third-party app for network files management.

 **Tips:**

You can also access your USB disk by using your Network/Media Server Name as the server address. Refer to [To Customize the Address of the USB Disk](#) to learn more.

9.1.2. Access the USB Device Remotely

You can access your USB disk outside the local area network. For example, you can:

- Share photos and other large files with your friends without logging in to (and paying for) a photo-sharing site or email system.
- Get a safe backup for the materials for a presentation.
- Remove the files on your camera's memory card from time to time during the journey.

Note:

If your ISP assigns a private WAN IP address (such as 192.168.x.x or 10.x.x.x), you cannot use this feature because private addresses are not routed on the Internet.

Follow the steps below to configure remote access settings.

1. Visit <http://tplinkwifi.net>, and log in with your TP-Link ID or the password you set for the router.
2. Go to **Advanced > USB Settings > Sharing Access** page.
3. Tick the **FTP(via Internet)** checkbox, and then click **Save**.

Sharing Settings

Network/Media Server Name:

Enable	Access Method	Link	Port
<input checked="" type="checkbox"/>	Network Neighborhood	\\TP-Share	---
<input checked="" type="checkbox"/>	FTP	ftp://192.168.0.99:21	21
<input checked="" type="checkbox"/>	FTP (Via Internet)	ftp://0.0.0.0:21 Edit	<input type="text" value="21"/>

4. Refer to the following table to access your USB disk remotely.

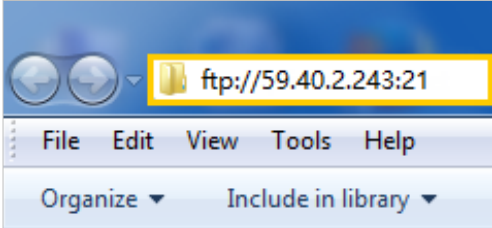
Computer	<ol style="list-style-type: none"> 1) Open the Windows Explorer (or go to Computer, only for Windows users) or open a web browser. 2) Type the server address in the address bar: Type in <code>ftp://<WAN IP address of the router>:<port number></code> (such as <code>ftp://59.40.2.243:21</code>). If you have specified the domain name of the router, you can also type in <code>ftp://<domain name>:<port number></code> (such as <code>ftp://MyDomainName:21</code>) <div data-bbox="644 527 1136 753" style="text-align: center;">  </div> <ol style="list-style-type: none"> 3) Press Enter on the keyboard. 4) Access with the username and password you set in To Set up Authentication for Data Security. <p><small>🔗 Tips:</small> You can also access the USB disk via a third-party app for network files management, which can resume broken file transfers.</p>
	Tablet

🔗 Tips:

Click [Set Up a Dynamic DNS Service Account](#) to learn how to set up a domain name for you router.

9.1.3. Customize the Access Settings

By default, all the network clients can access all folders on your USB disk. You can customize your sharing settings by setting a sharing account, sharing specific contents and setting a new sharing address on the router's web management page.

1. Visit <http://tplinkwifi.net>, and log in with your TP-Link ID or the password you set for the router.
2. Go to [Advanced](#) > [USB Settings](#) > [Sharing Access](#) page.

- **To Customize the Address of the USB Disk**

You can customize the server name and use the name to access your USB disk.

1. On the Sharing Settings part, make sure [Network Neighborhood](#) is ticked, and enter a Network/Media Server Name as you like, such as [MyShare](#), then click [Save](#).

Sharing Settings

Network/Media Server Name:

Enable	Access Method	Link	Port
<input checked="" type="checkbox"/>	Network Neighborhood	\\MyShare	---
<input checked="" type="checkbox"/>	FTP	ftp://192.168.0.99:21	21
<input type="checkbox"/>	FTP (Via Internet)	ftp://0.0.0.0:21 Edit	<input type="text" value="21"/>

[Save](#)

2. Now you can access the USB disk by visiting <\\MyShare> (for Windows) or <smb://MyShare> (for Mac).

- **To Only Share Specific Content**

1. Focus on the [Folder Sharing](#) section. Click the button to disable [Share All](#), then click [Add](#) to add a new sharing folder.

Folder Sharing

Share All: Toggle On to share all files and folders or keep it Off to only share the specified folders. [+ Add](#) [- Delete](#)

<input type="checkbox"/>	ID	Folder Name	Folder Path	Media Sharing	Volume Name	Status	Modify
<input type="checkbox"/>	--	--	--	--	--	--	--

Volume Name: [Browse](#)

Folder Path: [Browse](#)

Folder Name:

Allow Guest Network Access

[Enable Authentication](#)

[Enable Write Access](#)

[Enable Media Sharing](#)

[Cancel](#) [OK](#)

2. Select the [Volume Name](#) and [Folder Path](#), then enter a [Folder Name](#) as you like.

3. Decide the way you share the folder:

- **Enable Authentication:** Tick to enable authentication for this folder sharing, and you will be required to log in to the Sharing Account to access the USB disk. Refer to [To Set up Authentication for Data Security](#) to learn more.
- **Enable Write Access:** If you tick this checkbox, network clients can modify this folder.
- **Enable Media Sharing:** Tick to enable media sharing for this folder, and you can view photos, play music and watch movies stored on the USB disk directly from DLNA-supported devices. Click [Media Sharing](#) to learn more.

4. Click **OK**.

Tips:

The router can share 32 volumes at most. You can click  on the page to detach the corresponding volume you do not need to share.

USB Storage Device

Scan

Kingston DataTraveler G2  Safely Remove

ID	Volume Name	Capacity	Free Space	Active
1	sda1	7.5 GB	1.6 GB	

- **To Set up Authentication for Data Security**

You can set up authentication for your USB device so that network clients will be required to enter username and password when accessing the USB disk.

1. On the Sharing Account part, Choose [Use Default Account](#) or [Use New Account](#). The username and password are both **admin** for default account. If your choose [Use New Account](#), you have to customize the username and a password.

Sharing Account

Content sharing requires a sharing account. You can use the default account or create a new one

Account: Use Default Account Use New Account

Username:

Password: 

Save

Note:

For Windows users, do not set the sharing username the same as the Windows username. Otherwise, Windows credential mechanism may cause the following problems:

- If the sharing password is also the same as the Windows password, authentication will not work since the Windows will automatically use its account information for USB access.
- If the sharing password is different from the Windows password, the Windows will be unable to remember your credentials and you will always be required to enter the sharing password for USB access.

2. Enable **Authentication** to apply the account you just set.

- If you leave **Share All** enabled, click the button to enable **Authentication** for all folders.

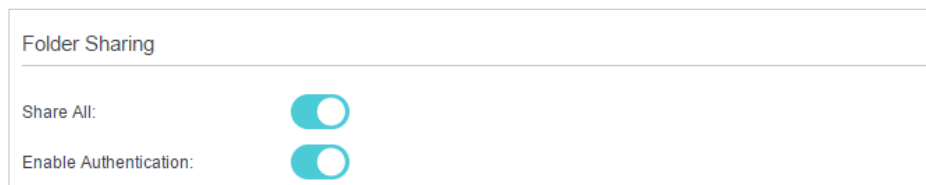

Folder Sharing

Share All:

Enable Authentication:

- If **Share All** is disabled, enable **Authentication** for specific folders.

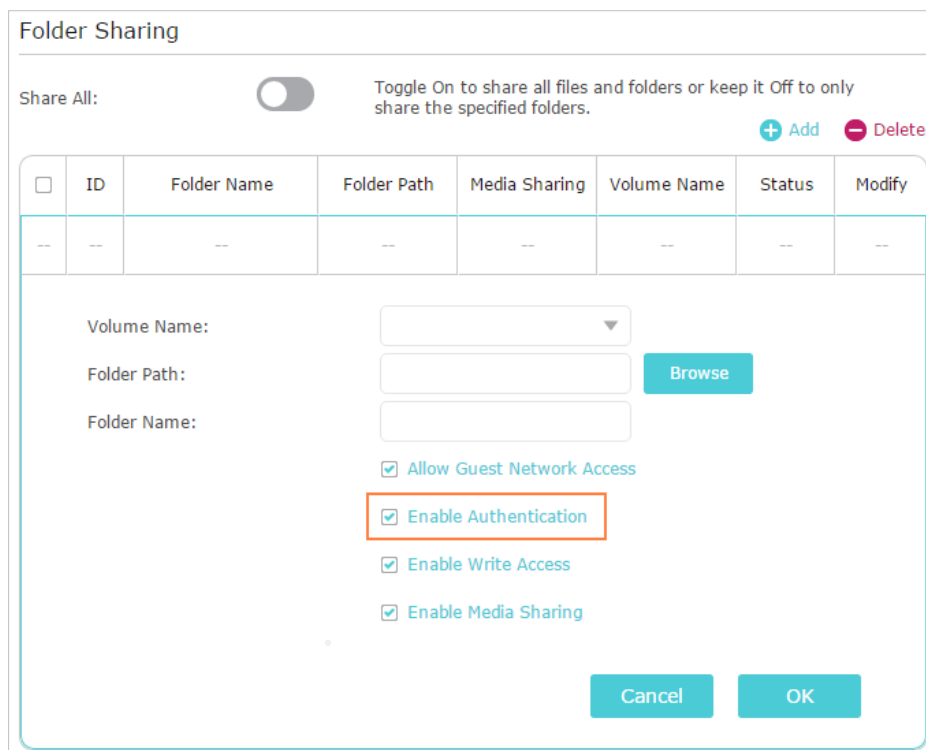

Folder Sharing

Share All: Toggle On to share all files and folders or keep it Off to only share the specified folders.

[+ Add](#) [- Delete](#)

<input type="checkbox"/>	ID	Folder Name	Folder Path	Media Sharing	Volume Name	Status	Modify
<input type="checkbox"/>	--	--	--	--	--	--	--

Volume Name:

Folder Path: [Browse](#)

Folder Name:

Allow Guest Network Access

Enable Authentication

Enable Write Access

Enable Media Sharing

[Cancel](#) [OK](#)

Note:

Due to Windows credential mechanism, you might be unable to access the USB disk after changing Authentication settings. Please log out from the Windows and try to access again. Or you can change the address of the USB disk by referring to [To Customize the Address of the USB Disk](#).

9.2. Media Sharing

The feature of [Media Sharing](#) allows you to view photos, play music and watch movies stored on the USB disk directly from DLNA-supported devices, such as your computer, tablet and PS2/3/4.

1. When your USB disk is inserted into the router, your DLNA-supported devices (such as your computer and pad) connected to the router can detect and play the media files on the USB disks.
2. Refer to the following table for detailed instructions.

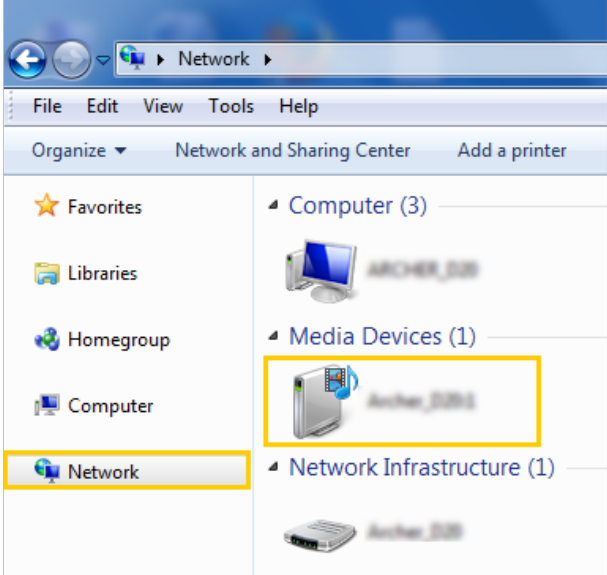
Windows Computer	<ul style="list-style-type: none"> • Go to Computer > Network, then click the Media Server Name (Model number-share by default) in the Media Devices section. <p>Note: Here we take Windows 7 as an example.</p>  <p>The screenshot shows the Windows 7 Network and Sharing Center. The 'Network' link in the left sidebar is highlighted with a yellow box. The main pane shows a tree view with 'Computer (3)', 'Media Devices (1)', and 'Network Infrastructure (1)'. Under 'Media Devices (1)', a device icon labeled 'Archer_2011' is highlighted with a yellow box.</p>
Tablet	<ul style="list-style-type: none"> • Use a third-party DLNA-supported player.

9.3. Offline Download

With Offline Download enabled, the router can download files without keeping your computer powered on all the time.

Follow the steps below to add offline download tasks:

1. Insert your USB storage device into the router's USB port.

 **Tips:**

- If you use USB hubs, make sure no more than 4 devices are connected to the router.
 - If the USB storage device requires using bundled external power, make sure the external power has been connected.
 - If you use a USB hard drive, make sure its file system is FAT32 or NTFS.
 - Before you physically disconnect a USB device from the router, safely remove it to avoid data damage: Go to [Advanced](#) > [USB Settings](#) > [Device Settings](#) and click [Safely Remove](#).
2. Visit <http://tplinkwifi.net>, and log in with your TP-Link ID or the password you set for the router.
 3. Go to [Advanced](#) > [USB Settings](#) > [Offline Download](#) and toggle [Status](#) on to enable the Offline Download feature.

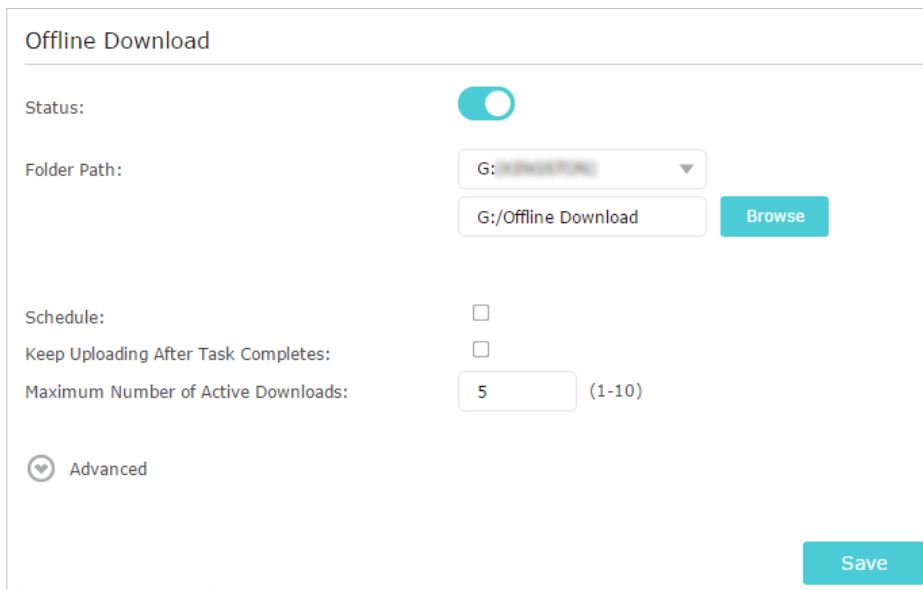

Offline Download

Status:

Folder Path:

Schedule:

Keep Uploading After Task Completes:

Maximum Number of Active Downloads: (1-10)

Advanced

4. Select a folder path to store or cache your downloads.

Note:

Don't change the folder path or unplug the USB storage device when uploading or downloading files; otherwise some fatal errors may occur.

5. Customize the settings as needed and click [Save](#).
 - [Schedule](#): Tick this checkbox and click  to specify the time period(s) to download or upload files.
 - [Keep Uploading After Task Completes](#): Tick this checkbox to keep uploading data of the completed download(s) to others.

- **Maximum Number of Active Downloads:** Enter a value between 1 and 10 to set the maximum number of active downloads.
6. Click **Add**, then select the source of your download. If it is a torrent file, select its location; if it is a URL, enter it. Click **OK**.

Downloads

↓ 0B/s ↑ 0B/s

+ Add
 - Delete
 || Pause
 ▶ Resume
 - Clear all completed tasks

☐	File	Speed	Completed	Remaining Time	Connected Peers	Status
--	--	--	--	--	--	--

Source: Torrent file from USB ▼

Volume Name: G: [unclear] ▼

File: G:/movie.torrent Browse

Cancel
 Save

Note:

If the source is a URL for aMule, click **Advanced** in the **Offline Download** section and specify the aMule server IP address and port number, and then click **Save**.

aMule Settings

aMule Server: 91.200.42.46 : 1176 ✖

Save

Chapter 10

Parental Controls

This function allows you to set up unique restrictions on internet access for each member of your family. You can block inappropriate content, set daily limits for the total time spent online and restrict internet access to certain times of the day.

It contains the following sections:

- [Set Up Access Restrictions](#)
- [Monitor Internet Usage](#)

10.1. Set Up Access Restrictions

I want to:

Block access to inappropriate online content for my child's devices, restrict internet access to 2 hours every day and block internet access during bed time (10 PM to 7 AM) on school nights (Sunday to Thursday).

How can I do that?

1. Visit <http://tplinkwifi.net>, and log in with your TP-Link ID or the password you set for the router.
2. Go to [Basic > Parental Controls](#) or [Advanced > Parental Controls](#).
3. Click [+](#) **Add** to create a profile for a family member.
4. Add basic profile information.

- 1) Enter a **Name** for the profile to make it easier to identify.
- 2) Under **Devices**, click [+](#).
- 3) Select the devices that belong to this family member. Access restrictions will be applied to these devices. Click **Save** when finished.

Note: Only devices that have previously been connected to your router's network are listed here. If you are unable to find the device you want to add, connect it to your network and then try again.
- 4) Click **Next**.
5. Customize the block content for this profile according to your needs.

Profiles + Add

Name	Time Limits	Devices	Insights	Internet Access	Modify
--	--	--	--	--	--

Blocked Content

Basic Info Time Controls

Blocked Content

Block all websites that contain a specific keyword.

Add a New Keyword: Add

Cancel
Back
Next

5) Add one or more keywords. All websites containing the keywords will be blocked.

6) Click [Next](#).

6. Set time restrictions on internet access.

Profiles + Add

Name	Time Limits	Devices	Insights	Internet Access	Modify
--	--	--	--	--	--

Blocked Content

Basic Info Time Controls

Time Limits

Set daily time limits for the total time spent online.

Mon to Fri Enable 2h

Sat & Sun Enable 2h

Bed Time

Set a time period when this profile cannot access the internet.

School Nights (Sunday - Thursday) Enable From: 10 : 00 PM To: 07 : 00 AM

Weekend (Friday and Saturday) Enable

Cancel
Back
Save

- 1) Enable [Time Limits](#) on Monday to Friday and Saturday & Sunday, then set the allowed online time to 2 hours each day.
- 2) Enable [Bed Time](#) on School Nights and use the up/down arrows or enter times in the fields. Devices under this profile will be unable to access the internet during this time period.
- 3) Click [Save](#).

Done!

The amount of time your child spends online is controlled and inappropriate content is blocked on their devices.

10.2. Monitor Internet Usage

I want to:

Check which websites my child has visited and how much time they have spent online recently.

How can I do that?

1. Visit <http://tplinkwifi.net>, and log in with your TP-Link ID or the password you set for the router.
2. Go to [Basic > Parental Controls](#) or [Advanced > Parental Controls](#).
3. Set up a profile for your child. Refer to [Set Up Access Restrictions](#) for detailed instructions.
4. Find the profile and click  in the [Insights](#) column.

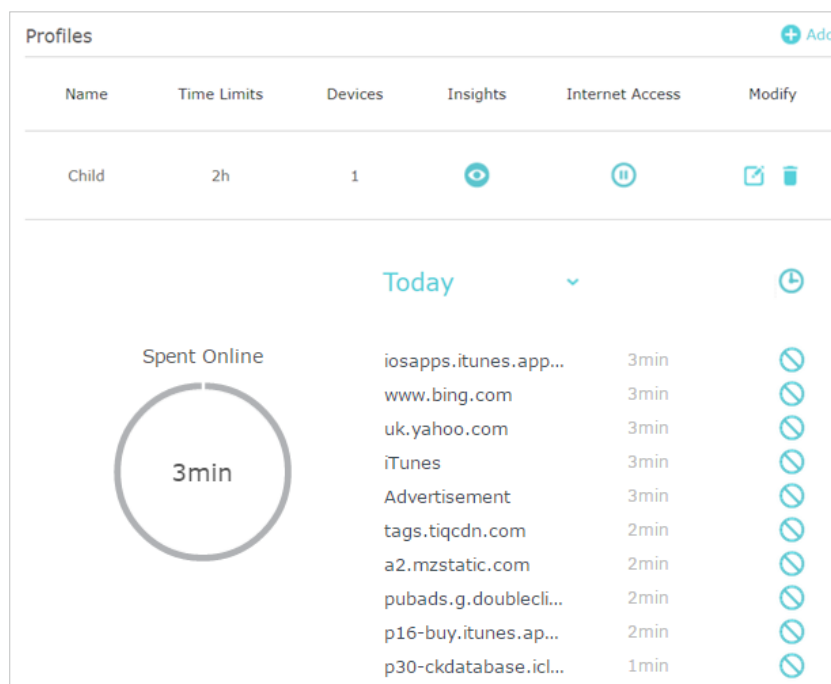

- Use the drop-down menu behind **Today** to view the websites visited and time spent online for any of the last 7 days. Click to view a complete history. Click to block the corresponding content for this profile.

Done!

You can now check up on your child's online activities.

Chapter 11

QoS

QoS (Quality of Service) allows you to prioritize the internet traffic of specific devices to guarantee a faster connection when you need it the most. Devices set as high priority will be allocated more bandwidth even when there is heavy traffic on the network.

I want to:

Ensure a fast connection while I use my computer for the next 2 hours.

How can I do that?

1. Visit <http://tplinkwifi.net>, and log in with your TP-Link ID or the password you set for the router.
2. Go to **Advanced > QoS**.
3. Enable **QoS**.
4. Enter the upload and download bandwidth provided by your internet service provider. Click **Save**.

Global Settings

QoS: Enable QoS

Upload Bandwidth: Mbps

Download Bandwidth: Mbps

Save

5. Under **Device Priority**, find your computer and toggle on **Priority**. Click the entry in the **Timing** column and select 2 hours as the duration you want the device to be prioritized for.

Type	Information	Real-time Rate	Traffic Usage	Priority	Timing
	FC-AA-14-55-FB-5D	↑ 0KB/s ↓ 0KB/s	9.8MB	<input checked="" type="checkbox"/>	2 hours 1 h 59 min Remaining
	C4-61-8B-CE-BF-32	↑ 0KB/s ↓ 0KB/s	14.3MB	<input type="checkbox"/>	-

Done!

You can now use your computer without lag for the next 2 hours.

Chapter 12

Network Security

This chapter guides you on how to protect your home network from cyber attacks and unauthorized users by implementing these three network security functions. You can protect your home network against DoS (Denial of Service) attacks from flooding your network with server requests using DoS Protection, block or allow specific client devices to access your network using Access Control, or you can prevent ARP spoofing and ARP attacks using IP & MAC Binding.

It contains the following sections:

- [Protect the Network from Cyber Attacks](#)
- [Access Control](#)
- [IP & MAC Binding](#)

12.1. Protect the Network from Cyber Attacks

The SPI (Stateful Packet Inspection) Firewall and DoS (Denial of Service) Protection protect the router from cyber attacks.

The SPI Firewall can prevent cyber attacks and validate the traffic that is passing through the router based on the protocol. This function is enabled by default, and it's recommended to keep the default settings.

DoS Protection can protect your home network against DoS attacks from flooding your network with server requests. Follow the steps below to configure DoS Protection.

1. Visit <http://tplinkwifi.net>, and log in with your TP-Link ID or the password you set for the router.
2. Go to [Advanced](#) > [Security](#) > [Settings](#).

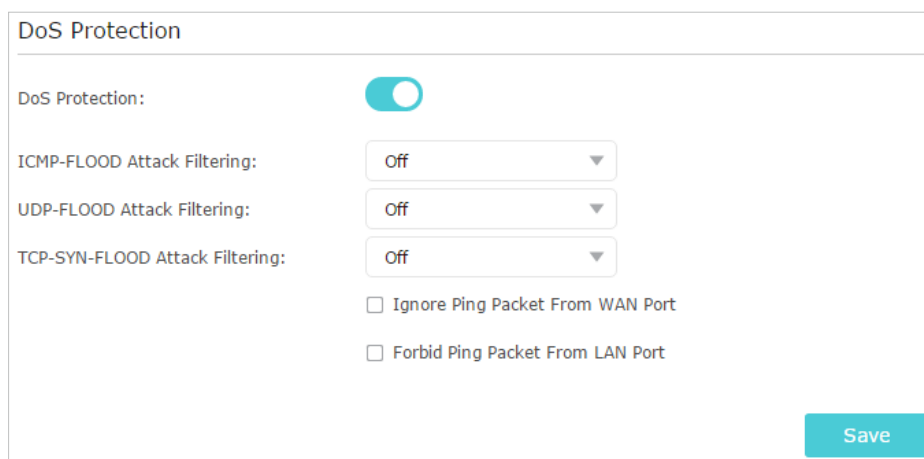

DoS Protection

DoS Protection:

ICMP-FLOOD Attack Filtering:

UDP-FLOOD Attack Filtering:

TCP-SYN-FLOOD Attack Filtering:

Ignore Ping Packet From WAN Port

Forbid Ping Packet From LAN Port

Save

3. Enable [DoS Protection](#).
4. Set the level ([Off](#), [Low](#), [Middle](#) or [High](#)) of protection for [ICMP-FLOOD Attack Filtering](#), [UDP-FLOOD Attack Filtering](#) and [TCP-SYN-FLOOD Attack Filtering](#).
 - [ICMP-FLOOD Attack Filtering](#) - Enable to prevent the ICMP (Internet Control Message Protocol) flood attack.
 - [UDP-FLOOD Attack Filtering](#) - Enable to prevent the UDP (User Datagram Protocol) flood attack.
 - [TCP-SYN-FLOOD Attack Filtering](#) - Enable to prevent the TCP-SYN (Transmission Control Protocol-Synchronize) flood attack.

 **Tips:**

The level of protection is based on the number of traffic packets. The protection will be triggered immediately when the number of packets exceeds the preset threshold value (the value can be set on [Advanced](#) > [System Tools](#) > [System Parameters](#) > [DoS Protection Level Settings](#)), and the vicious host will be displayed in the [Blocked DoS Host List](#).

Blocked DoS Host List			
Host Number: 0		Refresh Delete	
<input type="checkbox"/>	ID	IP Address	MAC Address
--	--	--	--

- If you want to ignore the ping packets from the WAN port, select [Ignore Ping Packet From WAN Port](#); if you want to ignore the ping packets form the LAN port, select [Ignore Ping Packet From LAN Port](#).
- Click [Save](#).

12.2. Access Control

Access Control is used to block or allow specific client devices to access your network (via wired or wireless) based on a list of blocked devices (Blacklist) or a list of allowed devices (Whitelist).

I want to:

Block or allow specific client devices to access my network (via wired or wireless).

How can I do that?

- Visit <http://tplinkwifi.net>, and log in with your TP-Link ID or the password you set for the router.
- Go to [Advanced](#) > [Security](#) > [Access Control](#).
- Enable [Access Control](#).

Access Control	
Access Control:	<input checked="" type="checkbox"/>

- Select the access mode to either block (recommended) or allow the device(s) in the list.

- To block specific device(s)**

- Select [Blacklist](#) and click [Save](#).

Access Mode	
Default Access Mode:	<input checked="" type="radio"/> Blacklist <input type="radio"/> Whitelist
Save	

- Select the device(s) to be blocked in the [Online Devices](#) table by ticking the box.

- 3) Click **Block** above the **Online Devices** table. The selected devices will be added to **Devices in Blacklist** automatically.

Online Devices						
<input checked="" type="checkbox"/>	ID	Device Name	IP Address	MAC Address	Connection Type	Modify
<input checked="" type="checkbox"/>	1	Roses-iPhone	192.168.0.175	1C-1A-C0-3B-28-4B	Wireless	
<input type="checkbox"/>	2	ADMIN-PC	192.168.0.157	C0-4A-00-1A-C3-45	Wireless	

- To allow specific device(s)

- 1) Select **Whitelist** and click **Save**.

Access Mode	
Default Access Mode:	<input type="radio"/> Blacklist <input checked="" type="radio"/> Whitelist
Save	

- 2) Click **Add** in the **Devices in Whitelist** section. Enter the **Device Name** and **MAC Address** (You can copy and paste the information from the **Online Devices** list if the device is connected to your network).

Devices in Whitelist				
<input type="checkbox"/>	ID	Device Name	MAC Address	Modify
<input type="checkbox"/>	--	--	--	--

Device Name:

MAC Address:

Cancel **OK**

- 3) Click **OK**.

Done!

Now you can block or allow specific client devices to access your network (via wired or wireless) using the **Blacklist** or **Whitelist**.

12.3. IP & MAC Binding

IP & MAC Binding, namely, ARP (Address Resolution Protocol) Binding, is used to bind network device's IP address to its MAC address. This will prevent ARP Spoofing and other ARP attacks by denying network access to an device with matching IP address in the Binding list, but unrecognized MAC address.

I want to:

Prevent ARP spoofing and ARP attacks.

How can I do that?

1. Visit <http://tplinkwifi.net>, and log in with your TP-Link ID or the password you set for the router.
2. Go to [Advanced](#) > [Security](#) > [IP & MAC Binding](#).
3. Enable [ARP Binding](#).



Settings

ARP Binding:

4. Bind your device(s) according to your need.

- **To bind the connected device(s):**

Click  to add the corresponding device to the [Binding List](#).

- **To bind the unconnected device**

- 1) Click [Add](#) in the [Binding List](#) section.

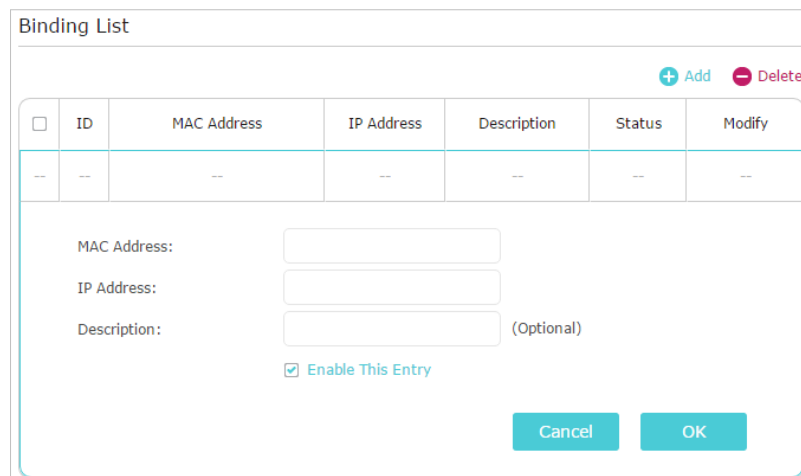

Binding List

[+ Add](#) [- Delete](#)

<input type="checkbox"/>	ID	MAC Address	IP Address	Description	Status	Modify
<input type="checkbox"/>	--	--	--	--	--	--

MAC Address:

IP Address:

Description: (Optional)

[Enable This Entry](#)

[Cancel](#) [OK](#)

- 2) Enter the [MAC address](#) and [IP address](#) that you want to bind. Enter a [Description](#) for this binding entry.
- 3) Tick the [Enable This Entry](#) checkbox and click [OK](#).

Done!

Now you don't need to worry about ARP spoofing and ARP attacks!

Chapter 13

NAT Forwarding

The router's NAT (Network Address Translation) feature makes devices on the LAN use the same public IP address to communicate with devices on the internet, which protects the local network by hiding IP addresses of the devices. However, it also brings about the problem that an external host cannot initiatively communicate with a specified device on the local network.

With the forwarding feature the router can penetrate the isolation of NAT and allows devices on the internet to initiatively communicate with devices on the local network, thus realizing some special functions.

The TP-Link router supports four forwarding rules. If two or more rules are set, the priority of implementation from high to low is Virtual Servers, Port Triggering, UPnP and DMZ.

It contains the following sections:

- [Share Local Resources on the Internet by Virtual Servers](#)
- [Open Ports Dynamically by Port Triggering](#)
- [Make Applications Free from Port Restriction by DMZ](#)
- [Make Xbox Online Games Run Smoothly by UPnP](#)

13. 1. Share Local Resources on the Internet by Virtual Servers

When you build up a server on the local network and want to share it on the internet, Virtual Servers can realize the service and provide it to internet users. At the same time Virtual Servers can keep the local network safe as other services are still invisible from the internet.

Virtual Servers can be used for setting up public services on your local network, such as HTTP, FTP, DNS, POP3/SMTP and Telnet. Different services use different service ports. Port 80 is used in HTTP service, port 21 in FTP service, port 25 in SMTP service and port 110 in POP3 service. Please verify the service port number before the configuration.

I want to:

Share my personal website I've built in local network with my friends through the internet. [For example](#), the personal website has been built on my home PC (192.168.0.100). I hope that my friends on the internet can visit my website in some way. The PC is connected to the router with the WAN IP address 218.18.232.154.

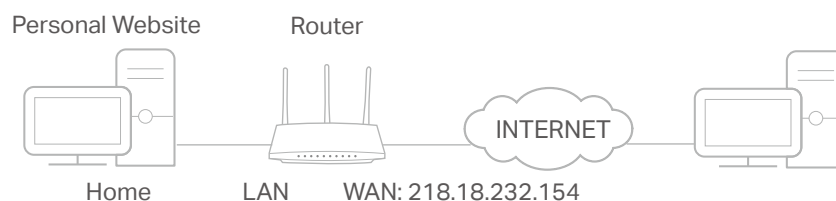

How can I do that?

1. Assign a static IP address to your PC, for example 192.168.0.100.
2. Visit <http://tplinkwifi.net>, and log in with your TP-Link ID or the password you set for the router.
3. Go to [Advanced > NAT Forwarding > Virtual Servers](#).
4. Click [Add](#). Click [View Existing Services](#) and select [HTTP](#). The [External Port](#), [Internal Port](#) and [Protocol](#) will be automatically filled in. Enter the PC's IP address 192.168.0.100 in the [Internal IP](#) field.
5. Click [OK](#).

Virtual Servers + Add - Delete

☐	ID	Service Type	External Port	Internal IP	Internal Port	Protocol	Status	Modify
--	--	--	--	--	--	--	--	--

Service Type: View Existing Services

External Port: (XX-XX or XX)

Internal IP:

Internal Port: (XX or Blank ,1-65535)

Protocol:

Enable This Entry

Cancel
OK

Tips:

- It is recommended to keep the default settings of [Internal Port](#) and [Protocol](#) if you are not clear about which port and protocol to use.
- If the service you want to use is not in the [Service Type](#), you can enter the corresponding parameters manually. You should verify the port number that the service needs.
- You can add multiple virtual server rules if you want to provide several services in a router. Please note that the [External Port](#) should not be overlapped.

Done!

Users on the internet can enter [http:// WAN IP](http://WAN IP) (in this example: [http:// 218.18.232.154](http://218.18.232.154)) to visit your personal website.

Tips:

- The WAN IP should be a public IP address. For the WAN IP is assigned dynamically by the ISP, it is recommended to apply and register a domain name for the WAN referring to [Set Up a Dynamic DNS Service Account](#). Then users on the internet can use [http:// domain name](http://domain name) to visit the website.
- If you have changed the default [External Port](#), you should use [http:// WAN IP: External Port](http://WAN IP: External Port) or [http:// domain name: External Port](http://domain name: External Port) to visit the website.

13.2. Open Ports Dynamically by Port Triggering

Port Triggering can specify a triggering port and its corresponding external ports. When a host on the local network initiates a connection to the triggering port, all the external ports will be opened for subsequent connections. The router can record the IP address of the host. When the data from the internet return to the external ports, the router can forward them to the corresponding host. Port Triggering is mainly applied to online games, VoIPs, video players and common applications including MSN Gaming Zone, Dialpad and Quick Time 4 players, etc.

Follow the steps below to configure the Port Triggering rules:

1. Visit <http://tplinkwifi.net>, and log in with your TP-Link ID or the password you set for the router.
2. Go to [Advanced](#) > [NAT Forwarding](#) > [Port Triggering](#) and click [Add](#).

3. Click [View Existing Applications](#), and select the desired application. The [Triggering Port](#), [External Port](#) and [Protocol](#) will be automatically filled in. The following picture takes application [MSN Gaming Zone](#) as an example.

4. Click [OK](#).

Port Triggering

+ Add - Delete

☐	ID	Application	Triggering Port	Triggering Protocol	External Port	External Protocol	Status	Modify
--	--	--	--	--	--	--	--	--

Application: [View Existing Applications](#)

Triggering Port: (XX,1-65535)

Triggering Protocol: ▼

External Port: (XX or XX-XX,1-65535,at most 5 pairs)

External Protocol: ▼

[Enable This Entry](#)

Tips:

- You can add multiple port triggering rules according to your network need.
- The triggering ports can not be overlapped.
- If the application you need is not listed in the Existing Applications list, please enter the parameters manually. You should verify the external ports the application uses first and enter them into [External Port](#) field according to the format the page displays.

13.3. Make Applications Free from Port Restriction by DMZ

When a PC is set to be a DMZ (Demilitarized Zone) host on the local network, it is totally exposed to the internet, which can realize the unlimited bidirectional communication between internal hosts and external hosts. The DMZ host becomes a virtual server with all ports opened. When you are not clear about which ports to open in some special applications, such as IP camera and database software, you can set the PC to be a DMZ host.

Note:

When DMZ is enabled, the DMZ host is totally exposed to the internet, which may bring some potential safety hazards. If DMZ is not in use, please disable it in time.

I want to:

Make the home PC join the internet online game without port restriction.

For example, due to some port restriction, when playing the online games, you can login normally but cannot join a team with other players. To solve this problem, set your PC as a DMZ host with all ports open.

How can I do that?

1. Assign a static IP address to your PC, for example 192.168.0.100.
2. Visit <http://tplinkwifi.net>, and log in with your TP-Link ID or the password you set for the router.
3. Go to **Advanced > NAT Forwarding > DMZ** and select **Enable DMZ**.
4. Enter the IP address 192.168.0.100 in the **DMZ Host IP Address** field.

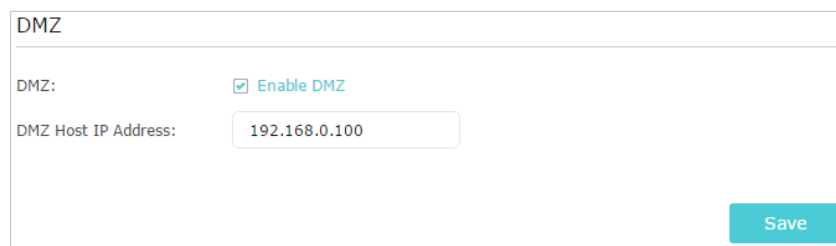

DMZ

DMZ: Enable DMZ

DMZ Host IP Address:

Save

5. Click **Save**.

Done!

The configuration is completed. You've set your PC to a DMZ host and now you can make a team to game with other players.

13.4. Make Xbox Online Games Run Smoothly by UPnP

The UPnP (Universal Plug and Play) protocol allows applications or host devices to automatically find the front-end NAT device and send request to it to open the corresponding ports. With UPnP enabled, the applications or host devices on the local network and the internet can freely communicate with each other thus realizing the seamless connection of the network. You may need to enable the UPnP if you want to use applications for multiplayer gaming, peer-to-peer connections, real-time communication (such as VoIP or telephone conference) or remote assistance, etc.

☛ **Tips:**

- UPnP is enabled by default in this router.
- Only the application supporting UPnP protocol can use this feature.
- UPnP feature needs the support of operating system (e.g. Windows Vista/ Windows 7/ Windows 8, etc. Some of operating system need to install the UPnP components).

For example, when you connect your Xbox to the router which has connected to the internet to play online games, UPnP will send request to the router to open the corresponding ports allowing the following data penetrating the NAT to transmit. Therefore, you can play Xbox online games without a hitch.

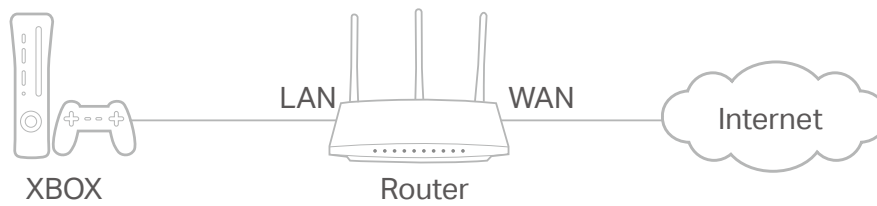

If necessary, you can follow the steps to change the status of UPnP.

1. Visit <http://tplinkwifi.net>, and log in with your TP-Link ID or the password you set for the router.
2. Go to **Advanced > NAT Forwarding > UPnP** and toggle on or off according to your needs.

UPnP

UPnP:

UPnP Service List

Total Clients: 0 [Refresh](#)

ID	Service Description	External Port	Protocol	Internal IP Address	Internal Port
--	--	--	--	--	--

Chapter 14

VPN Server

The VPN (Virtual Private Networking) Server allows you to access your home network in a secured way through internet when you are out of home. The router offers two ways to setup VPN connection: OpenVPN and PPTP (Point to Point Tunneling Protocol) VPN.

OpenVPN is somewhat complex but with greater security and more stable. It is suitable for restricted environment, such as campus network and company intranet.

PPTP VPN is more easily used and its speed is faster, it's compatible with most operating systems and also supports mobile devices. Its security is poor and your packets may be cracked easily, and PPTP VPN connection may be prevented by some ISP.

It contains the following sections, please choose the appropriate VPN server connection type as needed.

- [Use OpenVPN to Access Your Home Network](#)
- [Use PPTP VPN to Access Your Home Network](#)

14. 1. Use OpenVPN to Access Your Home Network

In the OpenVPN connection, the home network can act as a server, and the remote device can access the server through the router which acts as an OpenVPN Server gateway. To use the VPN feature, you should enable OpenVPN Server on your router, and install and run VPN client software on the remote device. Please follow the steps below to set up an OpenVPN connection.

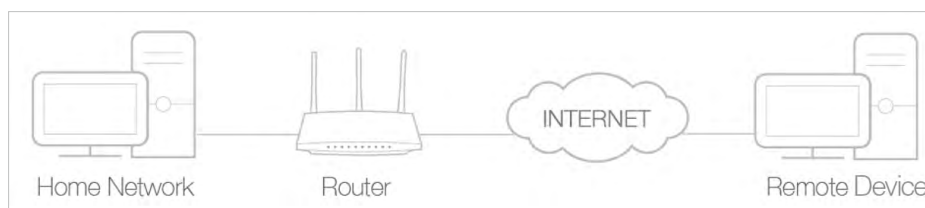

14. 1. 1. Step1. Set up OpenVPN Server on Your Router

1. Visit <http://tplinkwifi.net>, and log in with your TP-Link ID or the password you set for the router.
2. Go to **Advanced > VPN Server > OpenVPN**, and select **Enable VPN Server**.

OpenVPN

Note: No certificate currently, please **Generate** one before enabling VPN Server.

Enable VPN Server

Service Type: **UDP** TCP

Service Port:

VPN Subnet/Netmask:

Client Access: **Home Network Only** Internet and Home Network

Save

Note:

- Before you enable VPN Server, we recommend you configure Dynamic DNS Service (recommended) or assign a static IP address for router's WAN port and synchronize your System Time with internet.
- The first time you configure the OpenVPN Server, you may need to **Generate** a certificate before you enable the VPN Server.

3. Select the **Service Type** (communication protocol) for OpenVPN Server: UDP, TCP.
4. Enter a VPN **Service Port** to which a VPN device connects, and the port number should be between 1024 and 65535.
5. In the **VPN Subnet/Netmask** fields, enter the range of IP addresses that can be leased to the device by the OpenVPN server.

6. Select your **Client Access** type. Select **Home Network Only** if you only want the remote device to access your home network; select **Internet and Home Network** if you also want the remote device to access internet through the VPN Server.
7. Click **Save**.
8. Click **Generate** to get a new certificate.

Certificate

Generate the certificate.

Generate

Note:

If you have already generated one, please skip this step, or click **Generate** to update the certificate.

9. Click **Export** to save the OpenVPN configuration file which will be used by the remote device to access your router.

Configuration File

Export the configuration.

Export

14. 1. 2. Step 2. Configure OpenVPN Connection on Your Remote Device

1. Visit <http://openvpn.net/index.php/download/community-downloads.html> to download the OpenVPN software, and install it on your device where you want to run the OpenVPN client utility.

Note:

You need to install the **OpenVPN** client utility on each device that you plan to apply the VPN function to access your router. Mobile devices should download a third-party app from Google Play or Apple App Store.

2. After the installation, copy the file exported from your router to the OpenVPN client utility's "config" folder (for example, **C:\Program Files\OpenVPN\config** on Windows). The path depends on where the OpenVPN client utility is installed.
3. Run the OpenVPN client utility and connect it to OpenVPN Server.

14. 2. Use PPTP VPN to Access Your Home Network

PPTP VPN Server is used to create a VPN connection for remote device. To use the VPN feature, you should enable PPTP VPN Server on your router, and configure the PPTP connection on the remote device. Please follow the steps below to set up a PPTP VPN connection.

14.2.1. Step 1. Set up PPTP VPN Server on Your Router

1. Visit <http://tplinkwifi.net>, and log in with your TP-Link ID or the password you set for the router.
2. Go to [Advanced](#) > [VPN Server](#) > [PPTP VPN](#), and select [Enable VPN Server](#).

PPTP VPN

Enable VPN Server

Client IP Address: - 10.0.0. (up to 10 clients)

Advanced

Allow Samba (Network Place) access:

Allow NetBIOS passthrough:

Allow Unencrypted connections:

Note:

Before you enable [VPN Server](#), we recommend you configure Dynamic DNS Service (recommended) or assign a static IP address for router's WAN port and synchronize your [System Time](#) with internet.

3. In the [Client IP Address](#) field, enter the range of IP addresses (up to 10) that can be leased to the devices by the PPTP VPN server.
4. Click [Advanced](#) to set the PPTP connection permission according to your needs.
 - Select [Allow Samba \(Network Place\) access](#) to allow your VPN device to access your local Samba server.
 - Select [Allow NetBIOS passthrough](#) to allow your VPN device to access your Samba server using NetBIOS name.
 - Select [Allow Unencrypted connections](#) to allow unencrypted connections to your VPN server.
5. Click [Save](#).
6. Configure the PPTP VPN connection account for the remote device, you can create up to 16 accounts.

Account List (up to 16 users)

[+ Add](#) [- Delete](#)

<input type="checkbox"/>	ID	Username	Password	Modify
<input type="checkbox"/>	--	--	--	--

Username:

Password:

[Cancel](#) [OK](#)

<input type="checkbox"/>	1	admin	admin	✎ 🗑
--------------------------	---	-------	-------	-------------------------------------

- 1) Click [Add](#).
- 2) Enter the [Username](#) and [Password](#) to authenticate devices to the PPTP VPN Server.
- 3) Click [OK](#).

14.2.2. Step 2. Configure PPTP VPN Connection on Your Remote Device

The remote device can use the Windows built-in PPTP software or a third-party PPTP software to connect to PPTP Server. Here we use the [Windows built-in PPTP software](#) as an example.

1. Go to [Start > Control Panel > Network and Internet > Network and Sharing Center](#).
2. Select [Set up a new connection or network](#).

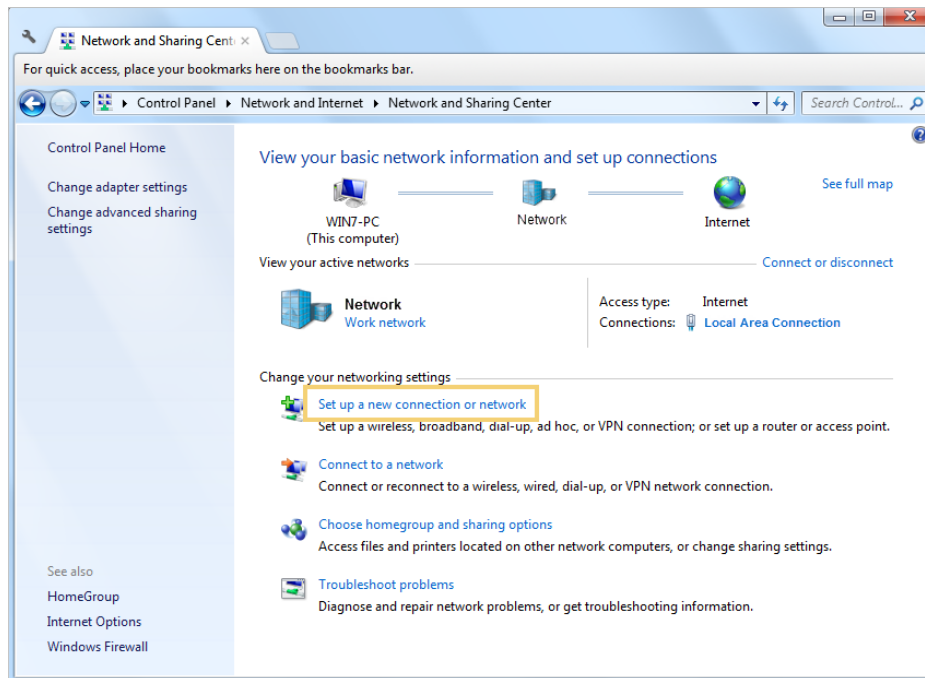

3. Select [Connect to a workplace](#) and click [Next](#).

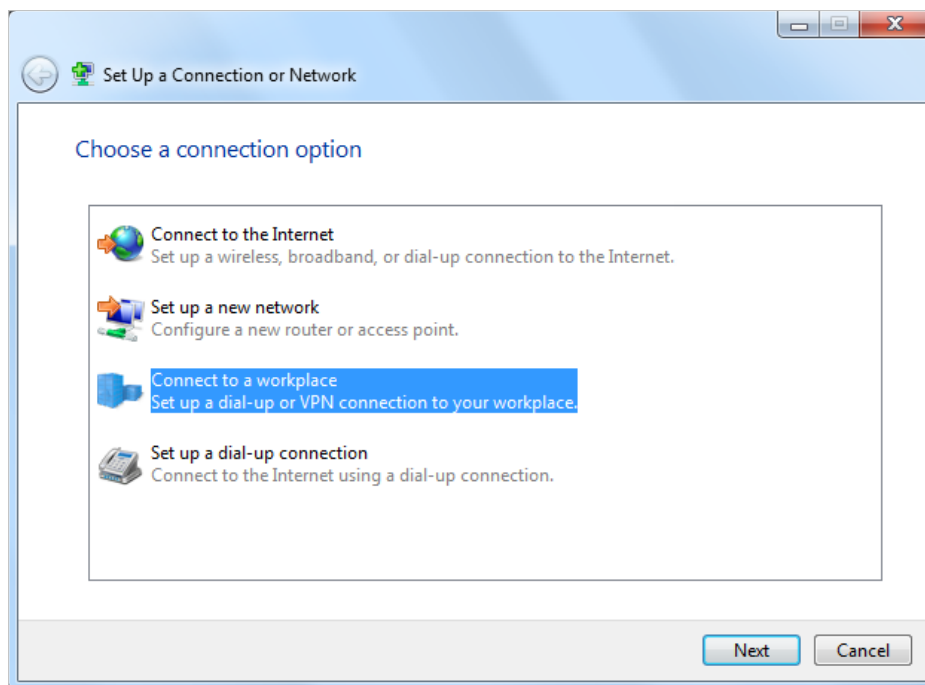

4. Select [Use my Internet connection \(VPN\)](#).

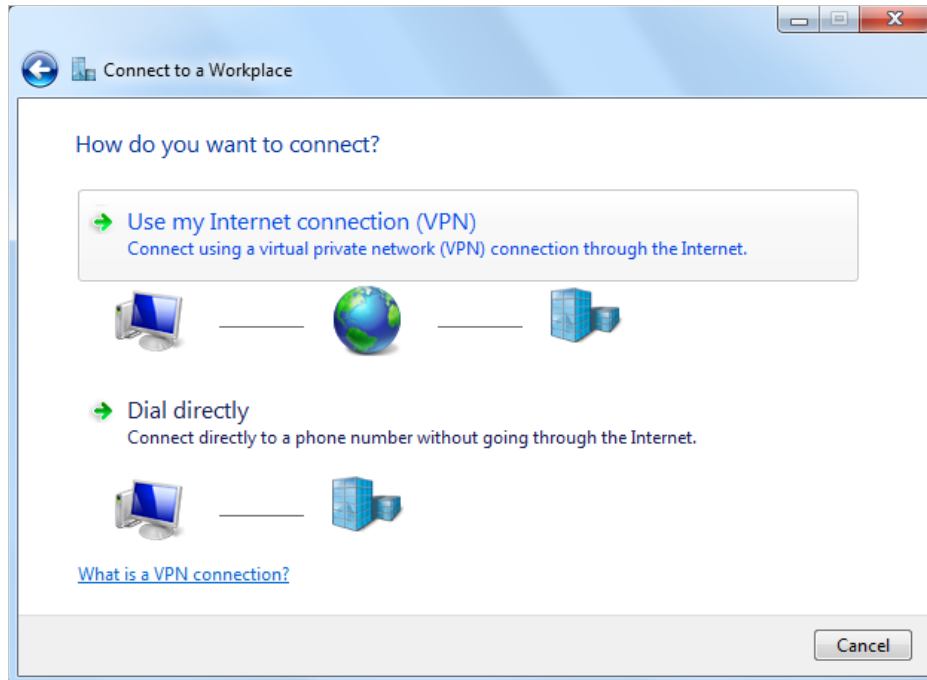

5. Enter the internet IP address of the router (for example: 218.18.1.73) in the **Internet address** field. Click **Next**.

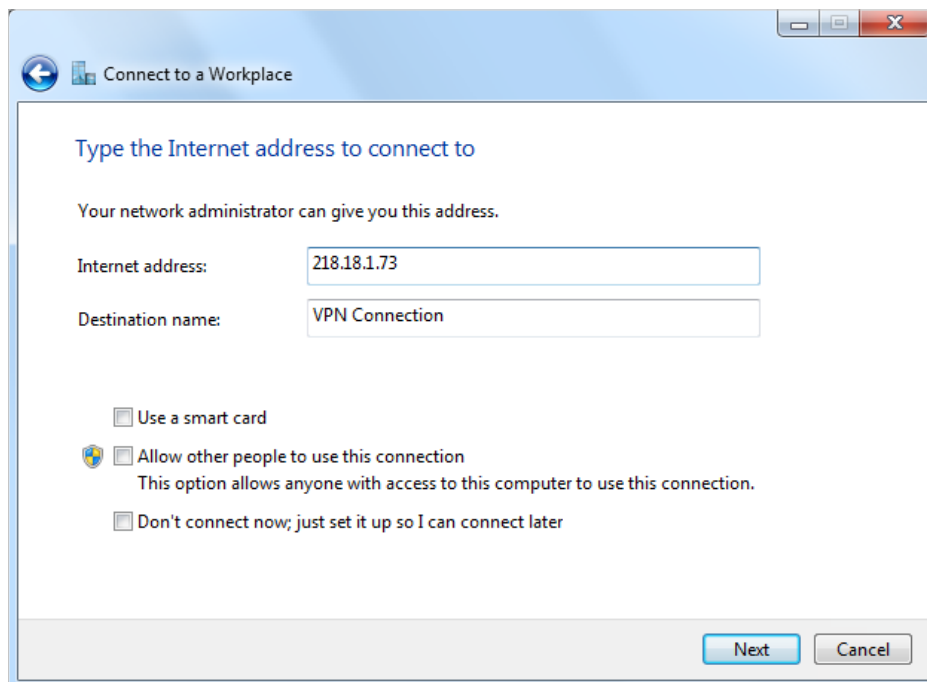

6. Enter the **User name** and **Password** you have set for the PPTP VPN server on your router, and click **Connect**.

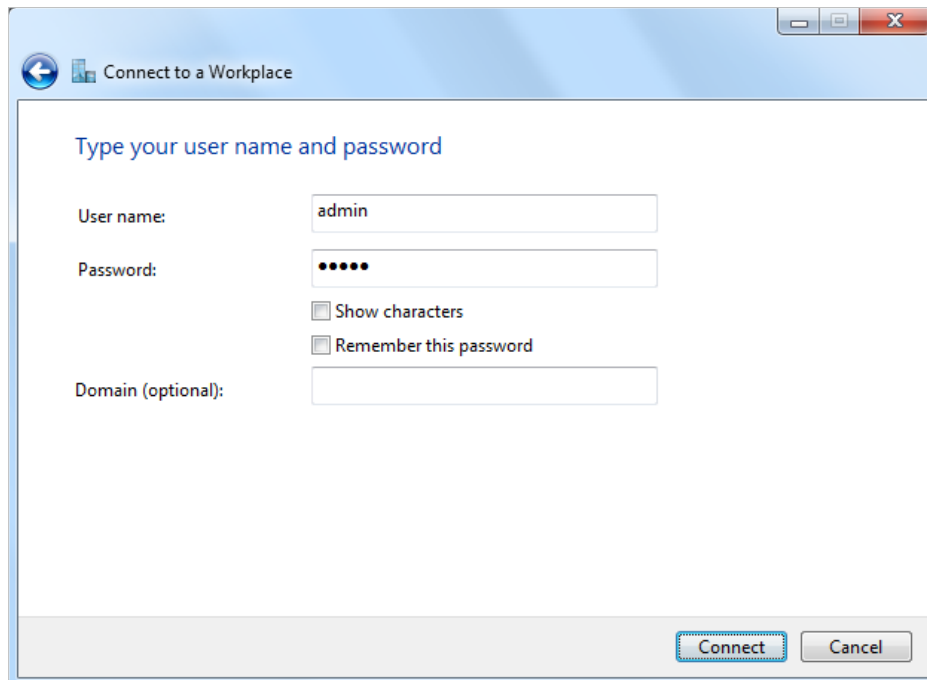

7. The PPTP VPN connection is created and ready to use.

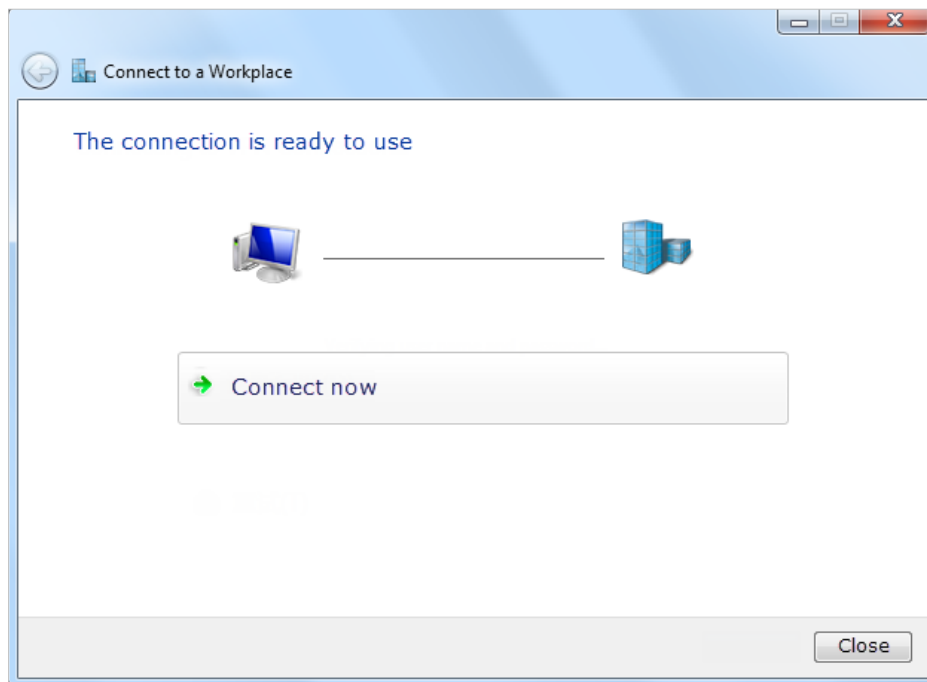

Chapter 15

Customize Your Network Settings

This chapter guides you on how to configure advanced network features.

It contains the following sections:

- [Change the LAN Settings](#)
- [Configure to Support IPTV Service](#)
- [Specify DHCP Server Settings](#)
- [Set Up a Dynamic DNS Service Account](#)
- [Create Static Routes](#)
- [Specify Wireless Settings](#)
- [Use WPS for Wireless Connection](#)

15.1. Change the LAN Settings

The router is preset with a default LAN IP 192.168.0.1, which you can use to log in to its web management page. The LAN IP address together with the Subnet Mask also defines the subnet that the connected devices are on. If the IP address conflicts with another device on your local network or your network requires a specific IP subnet, you can change it.

1. Visit <http://tplinkwifi.net>, and log in with your TP-Link ID or the password you set for the router.
2. Go to [Advanced](#) > [Network](#) > [LAN](#).
3. Type in a new IP Address appropriate to your needs. And leave the [Subnet Mask](#) as the default settings.

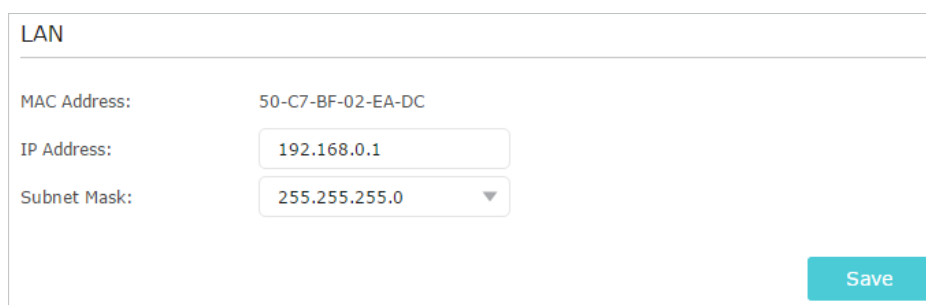

LAN

MAC Address: 50-C7-BF-02-EA-DC

IP Address: 192.168.0.1

Subnet Mask: 255.255.255.0

Save

4. Click [Save](#).

Note:

If you have set the Virtual Server, DMZ or DHCP address reservation, and the new LAN IP address is not in the same subnet with the old one, then you should reconfigure these features.

15.2. Configure to Support IPTV Service

I want to:

Configure IPTV setup to enable Internet/IPTV/Phone service provided by my internet service provider (ISP).

How can I do that?

1. Visit <http://tplinkwifi.net>, and log in with your TP-Link ID or the password you set for the router.
2. Go to [Advanced](#) > [Network](#) > [IPTV/VLAN](#).
3. **If your ISP provides the networking service based on IGMP technology**, for example, British Telecom(BT) and Talk Talk in UK:
 - 1) Check the box for [IGMP Proxy](#) and select the [IGMP Version](#), either V2 or V3, as required by your ISP.

The screenshot shows a 'Settings' panel with the following configuration:

- IGMP Snooping: Enable
- IGMP Proxy: Enable
- IGMP Version: V2 (selected from a dropdown menu)

- 2) Click [Save](#).
- 3) After configuring IGMP proxy, IPTV can work behind your router now. You can connect your set-top box to any of the router's Ethernet port.

If IGMP is not the technology your ISP applies to provide IPTV service:

- 1) Tick [Enable IPTV/VLAN](#).
- 2) Select the appropriate [Mode](#) according to your ISP.
 - Select [Bridge](#) if your ISP is not listed and no other parameters are required.
 - Select [Custom](#) if your ISP is not listed but provides necessary parameters.

The screenshot shows the 'IPTV/VLAN' configuration page with the following settings:

- Enable IPTV/VLAN
- Mode: Bridge (selected from a dropdown menu)
- LAN1: Singapore-Singtel
- LAN2: Malaysia-Unifi
- LAN3: Malaysia-Maxis-1
- LAN4: Malaysia-Maxis-2
- Portugal-MEO
- Portugal-Vodafone

A 'Save' button is visible at the bottom right of the form.

- 3) After you have selected a mode, the necessary parameters, including the LAN port for IPTV connection, are predetermined. If not, select the LAN type to determine which port is used to support IPTV service.
- 4) Click [Save](#).
- 5) Connect the set-top box to the corresponding LAN port which is predetermined or you have specified in Step 3.

Done!

Your IPTV setup is done now! You may need to configure your set-top box before enjoying your TV.

15.3. Specify DHCP Server Settings

By default, the DHCP (Dynamic Host Configuration Protocol) Server is enabled and the router acts as a DHCP server; it dynamically assigns TCP/IP parameters to client devices from the IP Address Pool. You can change the settings of the DHCP Server if necessary, and you can reserve LAN IP addresses for specified client devices.

1. Visit <http://tplinkwifi.net>, and log in with your TP-Link ID or the password you set for the router.
 2. Go to [Advanced](#) > [Network](#) > [DHCP Server](#).
- **To specify the IP address that the router assigns:**

Settings

DHCP Server: Enable DHCP Server

IP Address Pool: -

Address Lease Time: minutes. (2-2880. The default value is 120.)

Default Gateway: (Optional)

Primary DNS: (Optional)

Secondary DNS: (Optional)

[Save](#)

1. Tick the [Enable DHCP Server](#) checkbox.
2. Enter the starting and ending IP addresses in the [IP Address Pool](#).
3. Enter other parameters if the ISP offers. The [Default Gateway](#) is automatically filled in and is the same as the LAN IP address of the router.
4. Click [Save](#).

- **To reserve an IP address for a specified client device:**

1. Click [Add](#) in the [Address Reservation](#) section.

Address Reservation

[+ Add](#) [- Delete](#)

<input type="checkbox"/>	ID	MAC Address	Reserved IP Address	Description	Status	Modify
<input type="checkbox"/>	--	--	--	--	--	--

MAC Address:

IP Address:

Description:

Enable This Entry

[Cancel](#) [OK](#)

2. Click [View Existing Devices](#) or enter the [MAC](#) address of the client device.

3. Enter the [IP address](#) to reserve for the client device.
4. Enter the [Description](#) for this entry.
5. Tick the [Enable This Entry](#) checkbox and click [OK](#).

15.4. Set Up a Dynamic DNS Service Account

Most ISPs assign a dynamic IP address to the router and you can use this IP address to access your router remotely. However, the IP address can change from time to time and you don't know when it changes. In this case, you might apply the DDNS (Dynamic Domain Name Server) feature on the router to allow you and your friends to access your router and local servers (FTP, HTTP, etc.) using a domain name without checking and remembering the IP address.

Note:

DDNS does not work if the ISP assigns a private WAN IP address (such as 192.168.1.x) to the router.

1. Visit <http://tplinkwifi.net>, and log in with your TP-Link ID or the password you set for the router.
2. Go to [Advanced](#) > [Network](#) > [Dynamic DNS](#).
3. Select the DDNS [Service Provider](#): TP-Link, NO-IP or DynDNS. It is recommended to select TP-Link so that you can enjoy TP-Link's superior DDNS service. Otherwise, please select NO-IP or DynDNS. If you don't have a DDNS account, you have to register first by clicking [Go to register](#).

Dynamic DNS

Service Provider: TP-Link NO-IP DynDNS

Current Domain Name: ---

Domain Name List

+ Register - Delete

□	Domain Name	Registered Date	Status	Operation	Modify
---	---	---	---	---	---

Note:

To enjoy TP-Link's DDNS service, you have to log in with a TP-Link ID. If you have not logged in with one, click [Log in](#).

Dynamic DNS

Service Provider: TP-Link NO-IP DynDNS

DDNS Unavailable

To use our superior TP-LINK DDNS service, please [Log in](#) with your TP-LINK Cloud account, or choose another service provider.

4. Click [Register](#) in the [Domain Name List](#) if you have selected TP-Link, and enter the [Domain Name](#) as needed.

Dynamic DNS

Service Provider: TP-Link NO-IP DynDNS

Current Domain Name: ---

Domain Name List

[+ Register](#) [- Delete](#)

	Domain Name	Registered Date	Status	Operation	Modify
<input type="checkbox"/>	--	--	--	--	--

If you have selected NO-IP or DynDNS, enter the username, password and domain name of your account.

Dynamic DNS

Service Provider: TP-Link NO-IP DynDNS [Go to register...](#)

Username:

Password:

Domain Name:

Update Interval:

WAN IP binding: Disable Enable

✘ Not launching

5. Click [Login and Save](#).

 **Tips:**

If you want to use a new DDNS account, please click [logout](#) first, and then log in with a new account.

15.5. Create Static Routes

Static routing is a form of routing that is configured manually by a network administrator or a user by adding entries into a routing table. The manually-configured routing information guides the router in forwarding data packets to the specific destination.

I want to:

Visit multiple networks and servers at the same time.

For example, in a small office, my PC can surf the internet through Router A, but I also want to visit my company's network. Now I have a switch and Router B. I connect the devices as shown in the following figure so that the physical connection between my PC and my company's server is established. To surf the internet and visit my company's network at the same time, I need to configure the static routing.

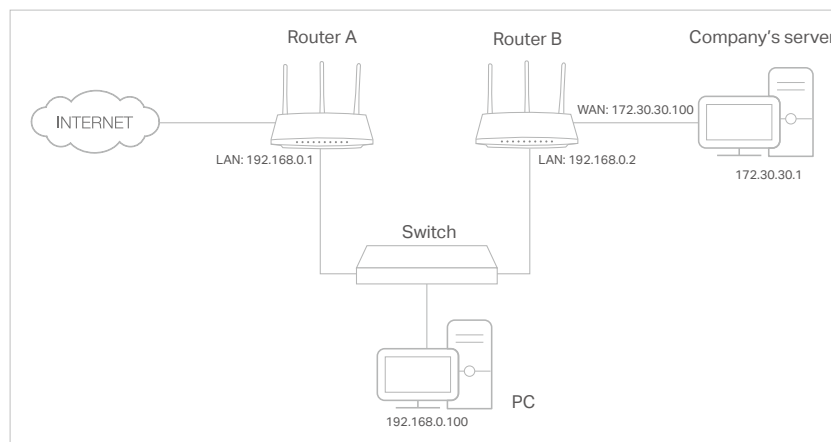

How can I do that?

1. Change the routers' LAN IP addresses to two different IP addresses on the same subnet. Disable Router B's DHCP function.
2. Visit <http://tplinkwifi.net>, and log in with your TP-Link ID or the password you set for Router A.
3. Go to **Network > Advanced Routing**.
4. Click **Add** and finish the settings according to the following explanations:

Static Routing

+ Add - Delete

☐	ID	Network Destination	Subnet Mask	Default Gateway	Interface	Description	Status	Modify
--	--	--	--	--	--	--	--	--

Network Destination:

Subnet Mask:

Default Gateway:

Interface:

Description:

Enable This Entry

Cancel
OK

Network Destination: The destination IP address that you want to assign to a static route. This IP address cannot be on the same subnet with the WAN IP or LAN IP of Router A. In the example, the IP address of the company network is the destination IP address, so here enter 172.30.30.1.

Subnet Mask: Determines the destination network with the destination IP address. If the destination is a single IP address, enter 255.255.255.255; otherwise, enter the subnet mask of the corresponding network IP. In the example, the destination network is a single IP, so here enter 255.255.255.255.

Default Gateway: The IP address of the gateway device to which the data packets will be sent. This IP address must be on the same subnet with the router's IP which sends out data. In the example, the data packets will be sent to the LAN port of Router B and then to the Server, so the default gateway should be 192.168.0.2.

Interface: Determined by the port (WAN/LAN) that sends out data packets. In the example, the data are sent to the gateway through the LAN port of Router A, so LAN should be selected.

Description: Enter a description for this static routing entry.

5. Click **OK**.
6. Check the **System Routing Table** below. If you can find the entry you've set, the static routing is set successfully.

System Routing Table

Active Routes Number: 1 ↻ Refresh

ID	Network Destination	Subnet Mask	Gateway	Interface
1	192.168.0.0	255.255.255.0	0.0.0.0	lan

Done!

Open a web browser on your PC. Enter the company server's IP address to visit the company network.

15.6. Specify Wireless Settings

The router's wireless network name (SSID) and password, and security option are preset in the factory. The preset SSID and password can be found on the label of the router. You can customize the wireless settings according to your needs.

Visit <http://tplinkwifi.net>, and log in with your TP-Link ID or the password you set for the router.

- **To enable or disable the wireless function:**

1. Go to [Basic > Wireless](#).
2. The wireless radio is enabled by default. If you want to disable the wireless function of the router, just untick the [Enable Wireless Radio](#) checkbox. In this case, all the wireless settings will be invalid.

- **To share a network:**

1. Go to [Basic > Wireless](#).
2. Click [Share Network](#) to share the SSID and password to others.

- **To use the Smart Connect function:**

Smart Connect allows each of the router's wireless bands to use the same wireless settings. The router can balance network demand and assign devices to the optimum band. Your mobile device can automatically switch connection to the Wi-Fi band that provides the fastest speed.

1. Go to [Basic > Wireless](#).
2. Enable [Smart Connect](#).

Smart Connect

Smart Connect:

Smart Connect allows your mobile device to automatically switch connection to the Wi-Fi band that provides the fastest speed.

Wireless Settings

Wireless: [Enable Wireless Radio](#) [Sharing Network](#)

Network Name (SSID): Hide SSID

Password:

[Save](#)

3. Keep the original or set a new SSID and password, then click [Save](#). This SSID and password will be applied for both 2.4GHz and 5GHz wireless networks.

- **To change the wireless network name (SSID) and wireless password:**

1. Go to [Basic](#) > [Wireless](#).
2. Create a new SSID in [Network Name \(SSID\)](#) and customize the password for the network in [Password](#). The value is case-sensitive.

Note:

If you change the wireless settings with a wireless device, you will be disconnected when the settings are effective. Please write down the new SSID and password for future use.

- **To hide SSID:**

1. Go to [Basic](#) > [Wireless](#).
2. Select [Hide SSID](#), and your SSID won't display when you scan for local wireless networks on your wireless device and you need to manually join the network.

- **To change the security option:**

1. Go to [Advanced](#) > [Wireless](#) > [Wireless Settings](#).
2. Select the wireless network [2.4GHz](#) or [5GHz](#).
3. Select an option from the [Security](#) drop-down list. We recommend you don't change the default settings unless necessary. If you select other options, configure the related parameters according to the help page.

In addition

- [Mode](#) - Select a transmission mode according to your wireless client devices. It is recommended to just leave it as default.
- [Channel Width](#) - Select a channel width (bandwidth) for the wireless network.

- **Channel** - Select an operating channel for the wireless network. It is recommended to leave the channel to **Auto**, if you are not experiencing the intermittent wireless connection issue.
- **Transmit Power** - Select either **High**, **Middle** or **Low** to specify the data transmit power. The default and recommended setting is **High**.

15.7. Use WPS for Wireless Connection

Wi-Fi Protected Setup (WPS) provides an easier approach to set up a security-protected Wi-Fi connection.

1. Visit <http://tplinkwifi.net>, and log in with your TP-Link ID or the password you set for the router.
2. Go to **Advanced > Wireless > WPS**.

15.7.1. Set the Router's PIN

Router's PIN is enabled by default to allow wireless devices to connect to the router using the PIN. You can use the default one or generate a new one.

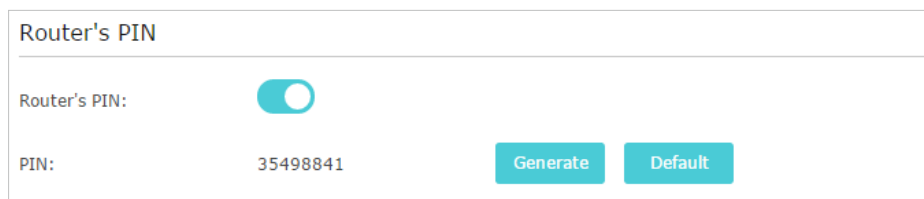

Router's PIN	
Router's PIN:	<input checked="" type="checkbox"/>
PIN:	35498841
	<input type="button" value="Generate"/> <input type="button" value="Default"/>

Note:

- If you want to enable/disable the WPS feature, go to **System Tools > System Parameters > WPS**, tick or untick the **Enable WPS** checkbox.
- PIN (Personal Identification Number) is an eight-character identification number preset to each router. WPS supported devices can connect to your router with the PIN. The default PIN is printed on the label of the router.

15.7.2. Use the WPS Wizard for Wi-Fi Connections

1. Select a setup method:
 - **Push Button(Recommended):** Click **Connect** on the screen. Within two minutes, press the WPS button on the client device.
 - **PIN:** Enter the client's PIN, and click **Connect**.

WPS Wizard

Select a WPS connection method: Push Button (Recommended) PIN

Enter the client's PIN:

2. **Success** will appear on the above screen and the WPS LED on the router will keep on for five minutes if the client has been successfully added to the network.

Chapter 16

Manage the Router

This chapter will show you the configuration for managing and maintaining your router.

It contains the following sections:

- [Set Up System Time](#)
- [Control LEDs](#)
- [Test the Network Connectivity](#)
- [Upgrade the Firmware](#)
- [Backup and Restore Configuration Settings](#)
- [Set the Router to Reboot Regularly](#)
- [Change the Login Password](#)
- [Password Recovery](#)
- [Local Management](#)
- [Remote Management](#)
- [System Log](#)
- [Monitor the Internet Traffic Statistics](#)

16.1. Set Up System Time

System time is the time displayed while the router is running. The system time you configure here will be used for other time-based functions like Parental Controls. You can choose the way to obtain the system time as needed.

1. Visit <http://tplinkwifi.net>, and log in with your TP-Link ID or the password you set for the router.
2. Go to [Advanced](#) > [System Tools](#) > [Time Settings](#). It is 12-hour time by default, and you can toggle on to change to 24-hour time.

- **To get time from the internet:**

1. In the [Set Time](#) field, select [Get automatically from the Internet](#).

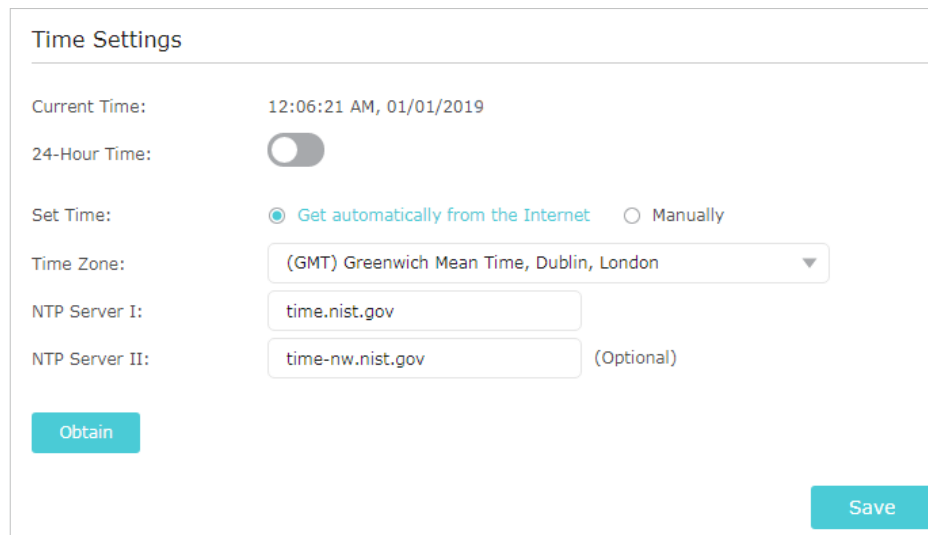

The screenshot shows the 'Time Settings' page. At the top, it displays 'Current Time: 12:06:21 AM, 01/01/2019'. Below this is a '24-Hour Time' toggle switch, which is currently turned off. The 'Set Time' section has two radio buttons: 'Get automatically from the Internet' (which is selected) and 'Manually'. The 'Time Zone' is set to '(GMT) Greenwich Mean Time, Dublin, London' in a dropdown menu. The 'NTP Server I' field contains 'time.nist.gov' and the 'NTP Server II' field contains 'time-nw.nist.gov' with '(Optional)' to its right. At the bottom left is an 'Obtain' button and at the bottom right is a 'Save' button.

2. Select your local [Time Zone](#) from the drop-down list.
3. In the [NTP Server I](#) field, enter the IP address or domain name of your desired NTP Server.
4. (Optional) In the [NTP Server II](#) field, enter the IP address or domain name of the second NTP Server.
5. Click [Obtain](#) to get the current Internet time and click [Save](#).

- **To manually set the date and time:**

1. In the [Set Time](#) field, select [Manually](#).

Time Settings

Current Time: 12:10:23 AM, 01/01/2019

24-Hour Time:

Set Time: Get automatically from the Internet Manually

Date: MM/DD/YYYY

Time: : : (HH/MM/SS)

[Save](#)

2. Set the current **Date** (In **MM/DD/YYYY** format).
3. Set the current **Time** (In **HH/MM/SS** format).
4. Click **Save**.

- **To set up Daylight Saving Time:**

1. Select **Enable Daylight Saving Time**.

Daylight Saving Time

Enable Daylight Saving Time

Start: 2019

End: 2019

Running Status: Daylight Saving Time is on.

[Save](#)

2. Select the correct **Start** date and time when daylight saving time starts at your local time zone.
3. Select the correct **End** date and time when daylight saving time ends at your local time zone.
4. Click **Save**.

16.2. Control LEDs

The router's LEDs indicate router's activities and status. You can turn on or turn off the LEDs either from the web management page or by pressing the LED button.

1. Visit <http://tplinkwifi.net>, and log in with your TP-Link ID or the password you set for the router.
2. Go to **Advanced > System Tools > System Parameters**.
3. In the **LED Control** section, toggle to turn on / off the LED.

4. You can enable **Night Mode** if needed, and set a time period, and then the LEDs will be off during this period.

The screenshot shows the 'LED Control' configuration page. At the top, 'LED Status' is shown with a toggle switch turned on. Below this is the 'Night Mode' section. A note states: 'Note: Before enabling Night Mode, please make sure the [System Time](#) is correct.' The 'Current Time' is displayed as '12:10:23 AM, 01/01/2019'. Under 'Night Mode: (everyday)', the 'Enable' checkbox is checked. The 'LED Off Time' is configured with 'From: 22:00' and 'To: 06:00 next day'. A 'Save' button is located at the bottom right of the form.

5. Click **Save**.

16.3. Test the Network Connectivity

Diagnostics is used to test the connectivity between the router and the host or other network devices.

1. Visit <http://tplinkwifi.net>, and log in with your TP-Link ID or the password you set for the router.
2. Go to **Advanced > System Tools > Diagnostics**.

The screenshot shows the 'Diagnostics' configuration page. Under 'Diagnostic Tool', the 'Ping' radio button is selected, and the 'Traceroute' radio button is unselected. Below this is an empty text input field for 'IP Address/Domain Name'. A 'Start' button is located at the bottom left of the form.

3. Enter the information with the help of page tips:

- 1) Choose **Ping** or **Traceroute** as the diagnostic tool to test the connectivity;
 - **Ping** is used to test the connectivity between the router and the tested host, and measure the round-trip time.
 - **Traceroute** is used to display the route (path) your router has passed to reach the tested host, and measure transit delays of packets across an Internet Protocol network.

2) Enter the [IP Address](#) or [Domain Name](#) of the tested host.

4. Click [Start](#) to begin the diagnostics.

 **Tips:**

Click [Advanced](#), you can modify the ping count, ping packet size or the Traceroute Max TTL. It's recommended to keep the default value.

The figure below indicates the proper connection between the router and the Yahoo server ([www.Yahoo.com](#)) tested through [Ping](#).

```

PING www.Yahoo.com (116.214.12.74): 64 data bytes
Reply from 116.214.12.74: bytes=64 ttl=50 seq=1 time=51.640 ms
Reply from 116.214.12.74: bytes=64 ttl=50 seq=2 time=53.671 ms
Reply from 116.214.12.74: bytes=64 ttl=50 seq=3 time=56.045 ms
Reply from 116.214.12.74: bytes=64 ttl=50 seq=4 time=57.857 ms

--- Ping Statistic "www.Yahoo.com" ---
Packets: Sent=4, Received=4, Lost=0 (0.00% loss)
Round-trip min/avg/max = 51.640/54.803/57.857 ms

```

The figure below indicates the proper connection between the router and the Yahoo server ([www.Yahoo.com](#)) tested through [Traceroute](#).

```

traceroute to www.Yahoo.com (116.214.12.74), 20 hops max, 38 byte packets
 1 219.133.12.1 (219.133.12.1) 19.556 ms 22.274 ms 22.024 ms
 2 113.106.38.77 (113.106.38.77) 30.115 ms 22.649 ms 20.931 ms
 3 * * *
 4 183.56.65.14 (183.56.65.14) 26.210 ms 29.428 ms 28.272 ms
 5 * 202.97.60.25 (202.97.60.25) 29.272 ms 25.461 ms
 6 202.97.60.46 (202.97.60.46) 27.335 ms 27.616 ms 28.272 ms
 7 202.97.60.149 (202.97.60.149) 22.805 ms 24.024 ms 24.711 ms
 8 202.97.6.30 (202.97.6.30) 47.610 ms 54.452 ms 61.137 ms
 9 r4105-s2.tp.hinet.net (220.128.6.110) 51.171 ms 50.515 ms 56.107 ms
10 220.128.11.190 (220.128.11.190) 60.950 ms 60.200 ms 60.419 ms

```

16.4. Upgrade the Firmware

TP-Link aims at providing better network experience for users.

We will inform you through the web management page if there's any update firmware available for your router. Also, the latest firmware will be released at the TP-Link official website [www.tp-link.com](#), and you can download it from the [Support](#) page for free.

 **Note:**

- Make sure you remove all attached USB devices from the router before the firmware upgrade to prevent data loss.
- Backup your router configuration before firmware upgrade.
- Do NOT turn off the router during the firmware upgrade.

16.4.1. Online Upgrade

1. Visit <http://tplinkwifi.net>, and log in with your TP-Link ID or the password you set for the router.

- When the latest firmware is available for your router, the update icon  will display in the top-right corner of the page. Click the icon to go to the [Firmware Upgrade](#) page. Alternatively, you can go to [Advanced](#) > [System Tools](#) > [Firmware Upgrade](#), and click [Check for upgrade](#) to see whether the latest firmware is released.



- Focus on the [Online Upgrade](#) section, and click [Upgrade](#).

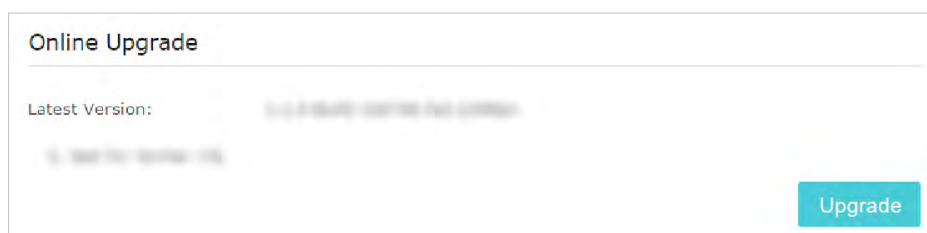

- Wait a few minutes for the upgrade and reboot to complete.

 **Tips:**

If there's a new and important firmware update for your router, you will see the notification (similar as shown below) on your computer as long as a web browser is opened. Click [Upgrade now](#), and log into the web management page with the username and password you set for the router. You will see the [Firmware Upgrade](#) page.

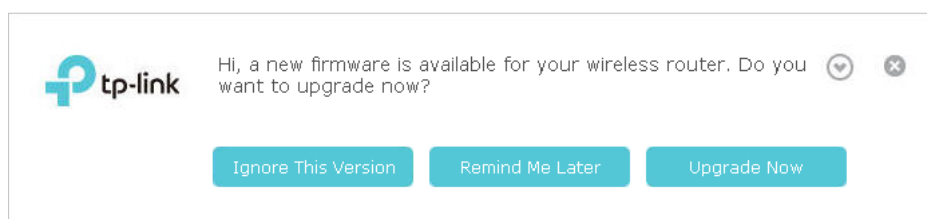

16.4.2. Manual Upgrade

- Download the latest firmware file for the router from www.tp-link.com.
- Visit <http://tplinkwifi.net>, and log in with your TP-Link ID or the password you set for the router.
- Go to [Advanced](#) > [System Tools](#) > [Firmware Upgrade](#).
- Focus on the Device Information section. Make sure the downloaded firmware file is matched with the [Hardware Version](#).
- Focus on the [Manual Upgrade](#) section. Click [Browse](#) to locate the downloaded new firmware file, and click [Upgrade](#).

6. Wait a few minutes for the upgrade and reboot to complete.

16.4.3. Restore Interrupted Upgrade after Power Failure

If your router cannot start up after an upgrade interruption due to power failure, follow the steps below to restore the interrupted upgrade. Otherwise, your router cannot work again.

1. Make sure you have the latest firmware file in your computer. If not, try another way to connect your computer to the Internet and download the latest firmware file from www.tp-link.com.
2. Connect your computer to the router with an Ethernet cable.
3. Visit 192.168.0.1 and you will see the following upgrade page.

4. Click [Browse](#) and select the downloaded firmware file.
5. Click [Upgrade](#) and wait for a few minutes until the router completes the upgrading and restarts.

16.5. Backup and Restore Configuration Settings

The configuration settings are stored as a configuration file in the router. You can backup the configuration file to your computer for future use and restore the router to a previous settings from the backup file when needed. Moreover, if necessary you can erase the current settings and reset the router to the default factory settings.

1. Visit <http://tplinkwifi.net>, and log in with your TP-Link ID or the password you set for the router.
2. Go to [Advanced](#) > [System Tools](#) > [Backup & Restore](#).

- **To backup configuration settings:**

Click [Backup](#) to save a copy of the current settings to your local computer. A '.bin' file of the current settings will be stored to your computer.

Backup

Save a copy of your current settings.

Backup

- **To restore configuration settings:**

1. Click [Browse](#) to locate the backup configuration file stored on your computer, and click [Restore](#).

Restore

Restore saved settings from a file.

File: [Browse](#)

Restore

2. Wait a few minutes for the restoring and rebooting.

■ **Note:** During the restoring process, do not turn off or reset the router.

- **To reset the router except your login password and TP-Link ID:**

1. Click [Restore](#) under the [Factory Default Restore](#) session.

Factory Default Restore

Restore all configuration settings to default values, except your login and cloud account information.

Restore

2. Wait a few minutes for the resetting and rebooting.

■ **Note:**

- During the resetting process, do not turn off the router.
- After reset, you can still use the current login password or the TP-Link ID to log in to the web management page.

- **To reset the router to factory default settings:**

1. Click [Factory Restore](#) to reset the router.

Factory Default Restore

Revert all the configuration settings to their default values.

Factory Restore

2. Wait a few minutes for the resetting and rebooting.

■ **Note:**

- During the resetting process, do not turn off or reset the router.
- We strongly recommend you backup the current configuration settings before resetting the router.

16.6. Set the Router to Reboot Regularly

The Scheduled Reboot feature cleans the cache to enhance the running performance of the router.

1. Visit <http://tplinkwifi.net>, and log in with your TP-Link ID or the password you set for the router.
2. Go to [Advanced](#) > [System Tools](#) > [Reboot Schedule](#).
3. Check the box to enable [Reboot Schedule](#).

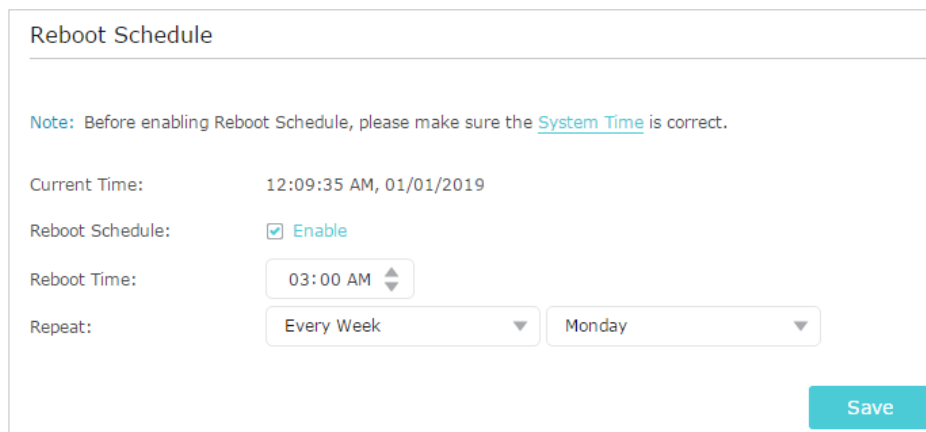

The screenshot shows the 'Reboot Schedule' configuration page. At the top, there is a title 'Reboot Schedule' and a note: 'Note: Before enabling Reboot Schedule, please make sure the [System Time](#) is correct.' Below the note, the 'Current Time' is displayed as '12:09:35 AM, 01/01/2019'. The 'Reboot Schedule' is set to 'Enable' with a checked checkbox. The 'Reboot Time' is set to '03:00 AM' using a time selector. The 'Repeat' section has two dropdown menus: 'Every Week' and 'Monday'. A 'Save' button is located at the bottom right of the form.

4. Specify the [Reboot Time](#) when the router reboots and [Repeat](#) to decide how often it reboots.
5. Click [Save](#).

16.7. Change the Login Password

The account management feature allows you to change your login password of the web management page.

Note:

If you are using a TP-Link ID to log in to the web management page, the account management feature will be disabled. To manage the TP-Link ID, go to [Basic](#) > [TP-Link Cloud](#).

1. Visit <http://tplinkwifi.net>, and log in with the password you set for the router.
2. Go to [Advanced](#) > [System Tools](#) > [Administration](#) and focus on the [Account Management](#) section.

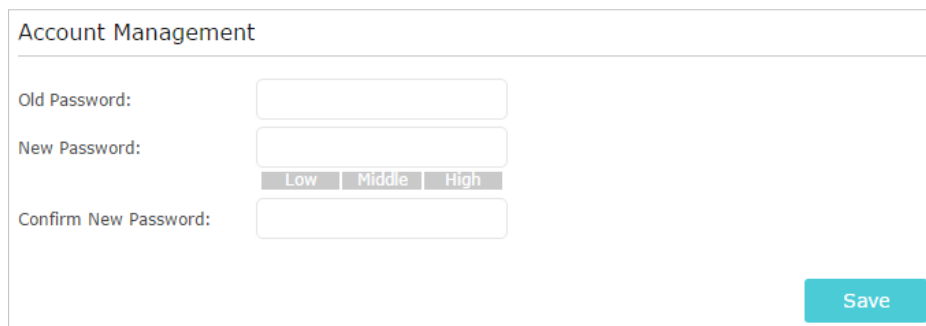

Account Management

Old Password:

New Password:

Low Middle High

Confirm New Password:

Save

3. Enter the old password, then a new password twice (both case-sensitive). Click [Save](#).
4. Use the new password for future logins.

16.8. Password Recovery

This feature allows you to recover the login password you set for your router in case you forget it.

Note:

If you are using a TP-Link ID to log in to the web management page, the Password Recovery feature will be disabled. To manage the TP-Link ID, go to [Basic](#) > [TP-Link Cloud](#).

1. Visit <http://tplinkwifi.net>, and log in with the password you set for the router.
2. Go to [Advanced](#) > [System Tools](#) > [Administration](#) and focus on the [Password Recovery](#) section.
3. Tick the [Enable Password Recovery](#) checkbox.
4. Specify a [mailbox \(From\)](#) for sending the recovery letter and enter its [SMTP Server](#) address. Specify a [mailbox \(To\)](#) for receiving the recovery letter. If the mailbox (From) to send the recovery letter requires encryption, select [Enable Authentication](#) and enter its username and password.

Tips:

- SMTP server is available for users in most webmail systems. For example, the SMTP server address of Gmail is smtp.gmail.com. You can refer to their Help page to learn the SMTP server address.
- Generally, Enable Authentication should be selected if the login of the mailbox requires username and password.

Password Recovery

[Enable Password Recovery](#)

From:

To:

SMTP Server:

[Enable Authentication](#)

Username:

Password:

5. Click [Save](#).

You can click [Test Email](#) to test whether the configuration is successful.

To recover the login password, please visit <http://tplinkwifi.net>, click [Forgot Password?](#) on the login page and follow the instructions to set a new password.

16.9. Local Management

This feature allows you to limit the number of client devices on your LAN from accessing the router by using the MAC address-based authentication.

1. Visit <http://tplinkwifi.net>, and log in with your TP-Link ID or the password you set for the router.
2. Go to [Advanced](#) > [System Tools](#) > [Administration](#) and complete the settings in [Local Management](#) section as needed.

- **Enable Local Management via HTTPS**

Toggle on [Local Management via HTTPS](#) if you want to access the router via HTTPS and HTTP, or keep it disabled if you only want to access the router via HTTP.

Local Management

Local Management via HTTPS:

- **Allow all LAN connected devices to manage the router:**

Toggle on [Access for All LAN Connected Devices](#).

Access for All LAN Connected Devices: Toggle On to enable the management for all devices on LAN or keep it Off to enable the management for a specific device.

- **Allow specific devices to manage the router:**
 1. Toggle off **Access for All LAN Connected Devices**.
 2. Click **Add**.

Access for All LAN Connected Devices: Toggle On to enable the management for all devices on LAN or keep it Off to enable the management for a specific device.

+ Add - Delete

<input type="checkbox"/>	ID	MAC Address	Description	Status	Modify
--	--	--	--	--	--

MAC Address: View Existing Devices

Description:

Enable This Entry

Cancel
OK

--	1	C0-4A-00-1A-C3-45	Your PC!	💡	✎ 🗑
----	---	-------------------	----------	---	-----

3. Click **View Existing Devices** and select the device to manage the router from the Existing Devices list, or enter the MAC address of the device manually.
4. Specify a **Description** for this entry.
5. Tick the **Enable This Entry** checkbox.
6. Click **OK**.

16. 10. Remote Management

This feature allows you to control remote devices' authority to manage the router.

1. Visit <http://tplinkwifi.net>, and log in with your TP-Link ID or the password you set for the router.
2. Go to **Advanced > System Tools > Administration**.
3. Enable **Remote Management**.

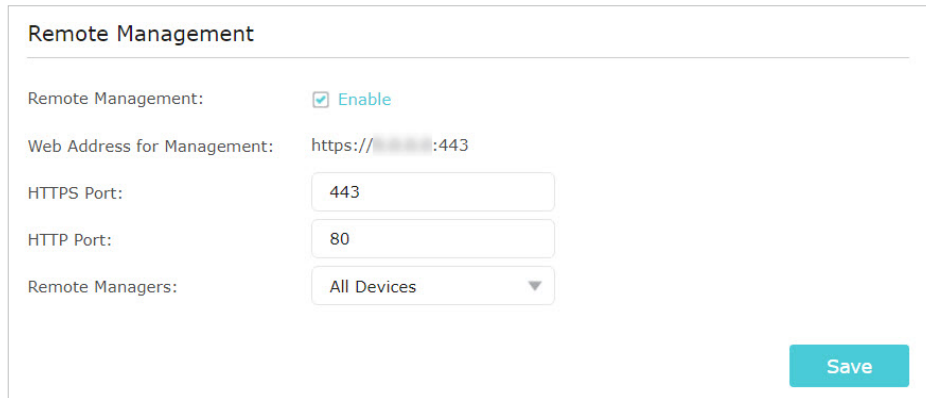

The screenshot shows the 'Remote Management' configuration page. It includes the following fields and options:

- Remote Management:** A checkbox labeled 'Enable' is checked.
- Web Address for Management:** A text field containing 'https://[redacted]:443'.
- HTTPS Port:** A text input field containing '443'.
- HTTP Port:** A text input field containing '80'.
- Remote Managers:** A dropdown menu currently set to 'All Devices'.
- Save:** A blue button located at the bottom right of the form.

4. Keep the HTTPS Port and HTTP Port as the default settings.
5. Decide which remote device can access the router remotely. Select [All Devices](#) to allow all remote devices to access the router, or select [Specified Device](#) and enter an IP address to allow only the remote device using the specified IP address.
6. Click [Save](#).

Now the specified remote device(s) can access the router from the internet via the displayed [Web Address for Management](#).

Note:

If a warning pops up when you visit the above address remotely, click Trust (or a similar option) to continue.

16. 11. System Log

When the router does not work normally, you can save the system log and send it to the technical support for troubleshooting.

- **To save the system log in local:**

1. Visit <http://tplinkwifi.net>, and log in your TP-Link ID or the password you set for the router.
2. Go to [Advanced](#) > [System Tools](#) > [System Log](#).
3. Choose the type and level of the system logs as needed.
4. Click [Save Log](#) to save the system logs to local.

System Log

Log Filter: Type= ALL and Level= ALL

Refresh Delete All

ID	Time	Type	Level	Log Content
1	2019-03-24 02:44:52	Locale	INFO	[16736] Language is changed to 'en_US'
2	2019-03-24 02:44:33	Locale	INFO	[16123] Language is changed to 'es_ES'

Mail Settings

Mail Log Save Log

- **To send the system log to a mailbox at a fixed time:**

For example, I want to check my router's working status at a fixed time every day, however, it's too troublesome to log in to the web management page every time I want to go checking. It would be great if the system logs could be sent to my mailbox at 8 a.m. every day.

1. Visit <http://tplinkwifi.net>, and log in with your TP-Link ID or the password you set for the router.
2. Go to [Advanced](#) > [System Tools](#) > [System Log](#).
3. Click [Mail Settings](#).
4. Enter the information required:

Mail Settings

From:

To:

SMTP Server:

Enable Authentication

Username:

Password:

Enable Auto Mail

Log at : (HH:MM) everyday

Log every hours

Save

- 1) **From:** Enter the email address used for sending the system log.

2) **To:** Enter the recipient's email address, which can be the same as or different from the sender's email address.

3) **SMTP Server:** Enter the SMTP server address.

☞ **Tips:** SMTP server is available for users in most webmail systems. For example, the SMTP server address of Hotmail is smtp-mail.outlook.com. You can refer to their Help page to learn the SMTP server address.

4) Select **Enable Authentication**.

☞ **Tips:** Generally, Enable Authentication should be selected if the login of the mailbox requires username and password.

5) **Username:** Enter the email address used for sending the system log.

6) **Password:** Enter the password to login the sender's email address.

7) Select **Enable Auto Mail**.

☞ **Tips:** The router will send the system log to the designated email address if this option is enabled.

8) Set a fixed time. The recipient will receive the system log sent at this time every day.

5. Click **Save**.

16. 12. Monitor the Internet Traffic Statistics

The Traffic Statistics page displays the network traffic of the LAN, WAN and WLAN sent and received packets, allowing you to monitor the volume of Internet traffic statistics.

1. Visit <http://tplinkwifi.net>, and log in with your TP-Link ID or the password you set for the router.
2. Go to **Advanced > System Tools > Traffic Statistics**.
3. Toggle on **Traffic Statistics**, and then you can monitor the traffic statistics in **Traffic Statistics List** section.

Traffic Statistics

Traffic Statistics:

Traffic Statistics List

🔄 Refresh 🔄 Reset All 🗑️ Delete All

IP Address/MAC Address	Total Packets	Total Bytes	Current Packets	Current Bytes	Modify
--	--	--	--	--	--

Click **Refresh** to update the statistic information on the page.

Click **Reset All** to reset all statistic values in the list to zero.

Click **Delete All** to delete all statistic information in the list.

Click  to reset the statistic information of the specific device.

Click  to delete the specific device item in the list.

FAQ

Q1. What should I do if I forget my wireless password?

The default wireless password is printed on the label of the router. If the password has been altered:

1. Connect your computer to the router using an Ethernet cable.
2. Visit <http://tplinkwifi.net>, and log in with your TP-Link ID or the password you set for the router.
3. Go to [Basic](#) > [Wireless](#) to retrieve or reset your wireless password.

Q2. What should I do if I forget my web management password?

- If you are using a TP-Link ID to log in, or you have enabled the Password Recovery feature of the router, click [Forgot password](#) on the login page and then follow the instructions to reset it.
- Alternatively, press and hold the Reset button of the router until the Power LED binks to reset it, and then visit <http://tplinkwifi.net> to create a new login password.

Note:

- Please refer to [Password Recovery](#) to learn how to configure Password Recovery.
- You'll need to reconfigure the router to surf the internet once the router is reset, and please mark down your new password for future use.

Q3. What should I do if I cannot log in to the router's web management page?

This can happen for a variety of reasons. Please try the methods below to log in again.

- Make sure your computer is connected to the router correctly and the corresponding LED indicator(s) light up.
- Make sure the IP address of your computer is configured as [Obtain an IP address automatically](#) and [Obtain DNS server address automatically](#).
- Make sure <http://tplinkwifi.net> or <http://192.168.0.1> is correctly entered.
- Check your computer's settings:
 - 1) Go to [Start](#) > [Control Panel](#) > [Network and Internet](#), and click [View network status and tasks](#).
 - 2) Click [Internet Options](#) on the bottom left.
 - 3) Click [Connections](#) and select [Never dial a connection](#).

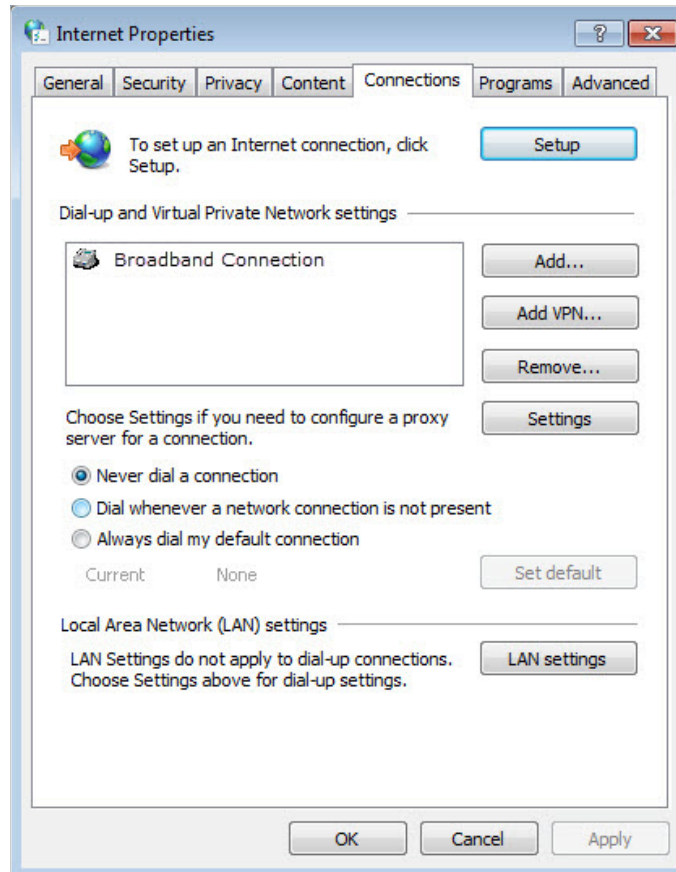

4) Click [LAN settings](#) and deselect the following three options and click [OK](#).

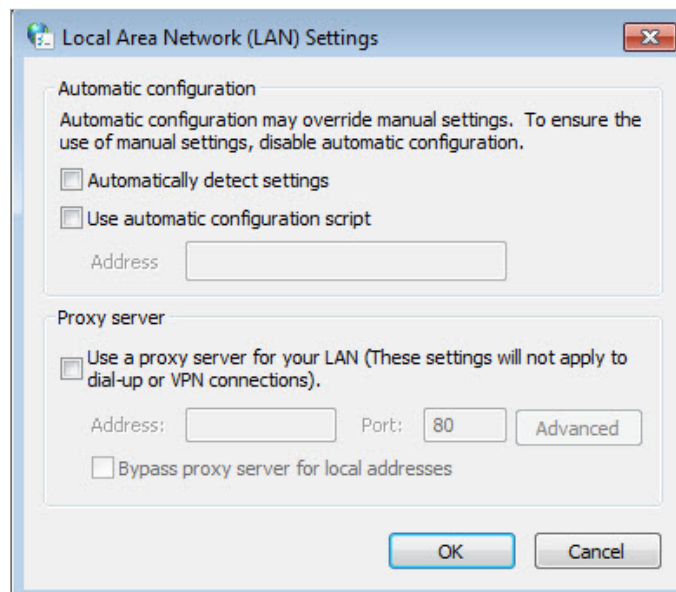

5) Go to [Advanced](#) > [Restore advanced settings](#), click [OK](#) to save the settings.

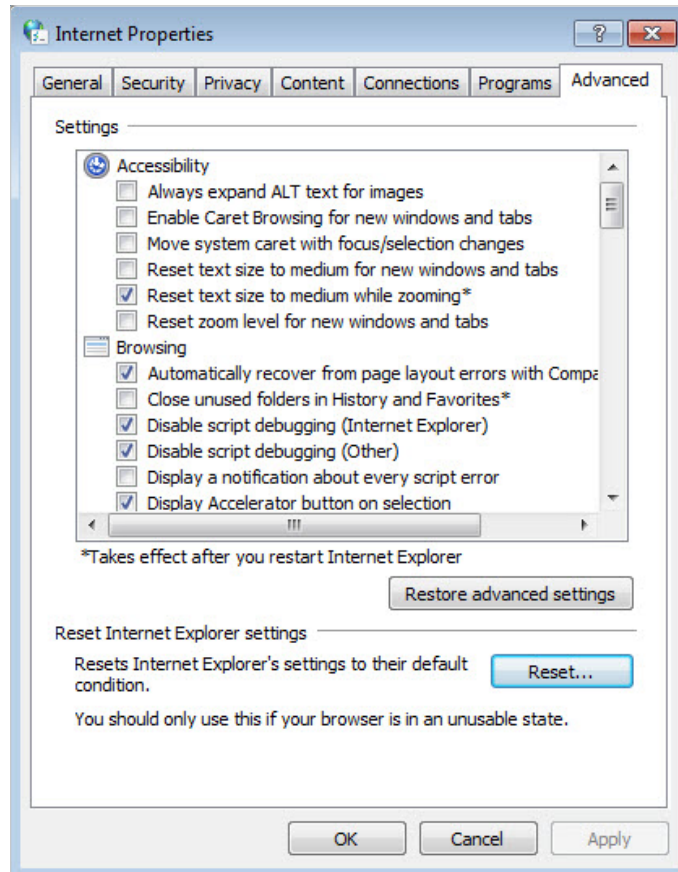

- Use another web browser or computer to log in again.
- Reset the router to factory default settings and try again. If login still fails, please contact the technical support.

■ Note: You'll need to reconfigure the router to surf the internet once the router is reset.

Q4. How do I use the WDS Bridging function to extend my wireless network?

For example, my house covers a large area. The wireless coverage of the router I'm using (the root router) is limited. I want to use an extended router to extend the wireless network of the root router.

■ Note:

- WDS bridging only requires configuration on the extended router.
- WDS bridging function can be enabled either in 2.4GHz frequency or 5GHz frequency for a dual-band router. We use the WDS bridging function in 2.4GHz frequency as example.

1. Visit <http://tplinkwifi.net>, and log in with your TP-Link ID or the password you set for the router.

2. Configure the IP address of the router:

- 1) Go to **Advanced > Network > LAN**, configure the IP address of the extended router to be in the same subnet with the root router; (For example, the IP address

of the root router is 192.168.0.1, the IP address of the extended router can be 192.168.0.2~192.168.0.254. We take 192.168.0.2 as example.)

2) Click [Save](#).

Note: Log in to the web management page again if the IP address of the router is altered.

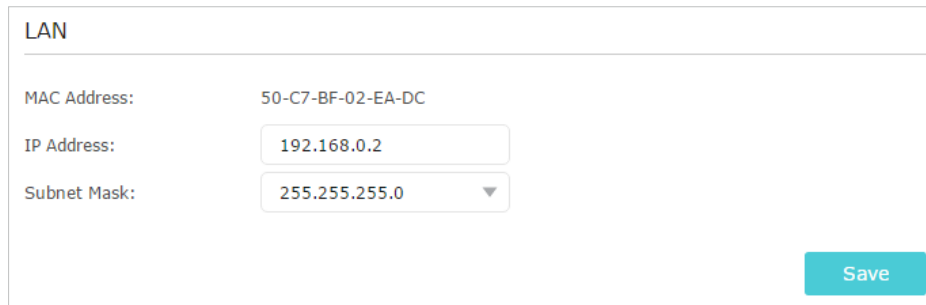

LAN

MAC Address: 50-C7-BF-02-EA-DC

IP Address: 192.168.0.2

Subnet Mask: 255.255.255.0

Save

3. Survey the SSID to be bridged:

- 1) Go to [Advanced](#) > [System Tools](#) > [System Parameters](#) and focus on the [2.4GHz WDS](#) section, click [Enable WDS Bridging](#).
- 2) Click [Survey](#), locate the root router's SSID and click [Choose](#) (Here we take TP-Link_4F98 as example).
- 3) If the root router has wireless password, you should enter the wireless password of the root router.
- 4) Click [Save](#).

4. Disable DHCP:

- 1) Go to [Network](#) > [DHCP Server](#).
- 2) Deselect [Enable DHCP Server](#) and click [Save](#).

Now you can go to [Advanced](#) > [Status](#) > [Wireless](#) to check the WDS status. When the [WDS status](#) is [Run](#), it means WDS bridging is successfully built.

Q5. What should I do if I cannot access the internet even though the configuration is finished?

1. Visit <http://tplinkwifi.net>, and log in with your TP-Link ID or the password you set for the router.
2. Go to [Advanced](#) > [Status](#) to check internet status:

As the follow picture shows, if IP Address is a valid one, please try the methods below and try again:

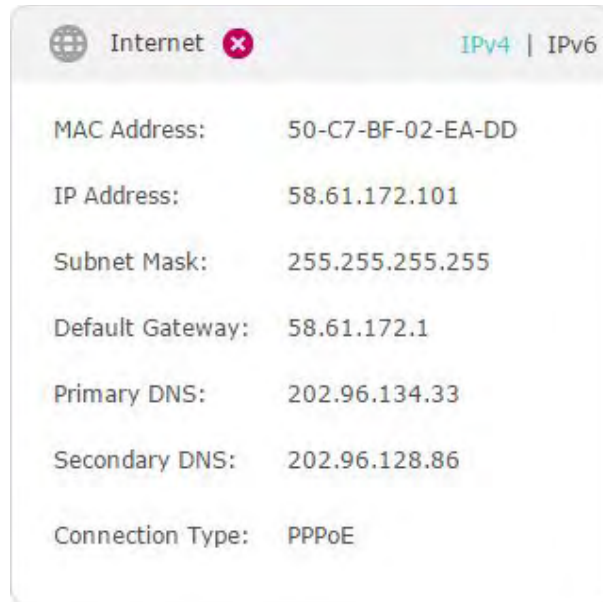

- Your computer might not recognize any DNS server addresses. Please manually configure the DNS server.

1) Go to [Advanced](#) > [Network](#) > [DHCP Server](#).

2) Enter 8.8.8.8 as Primary DNS, click [Save](#).

 **Tips:** 8.8.8.8 is a safe and public DNS server operated by Google.

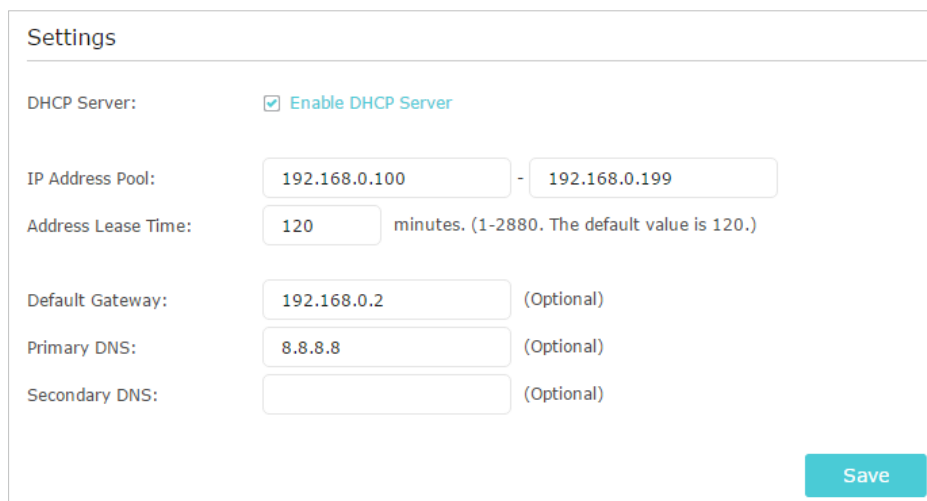

- Restart the modem and the router.
 - 1) Power off your modem and router, and leave them off for 1 minute.
 - 2) Power on your modem first, and wait about 2 minutes until it gets a solid cable or Internet light.
 - 3) Power on the router.
 - 4) Wait another 1 or 2 minutes and check the internet access.
- Reset the router to factory default settings and reconfigure the router.

- Upgrade the firmware of the router.
- Check the TCP/IP settings on the particular device if all other devices can get internet from the router.

As the picture below shows, if the IP Address is 0.0.0.0, please try the methods below and try again:

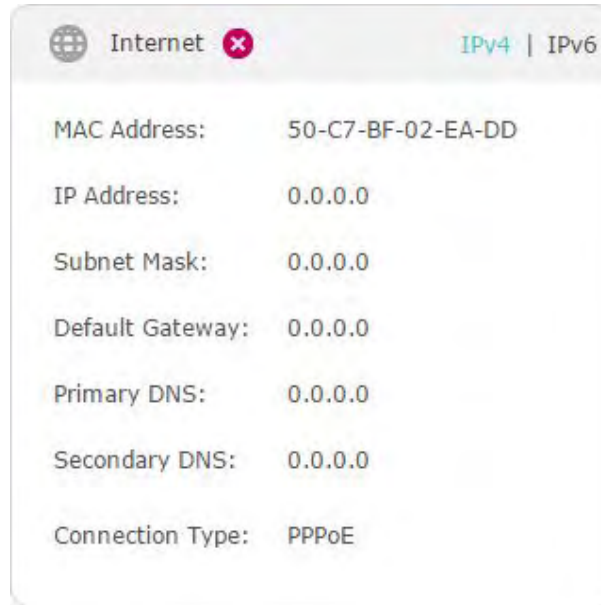

- Make sure the physical connection between the router and the modem is proper.
- Clone the MAC address of your computer.
 - 1) Visit <http://tplinkwifi.net>, and log in with your TP-Link ID or the password you set for the router.
 - 2) Go to **Advanced** > **Network** > **Internet** and focus on the **MAC Clone** section.
 - 3) Choose an option as needed (enter the MAC address if **Use Custom MAC Address** is selected), and click **Save**.

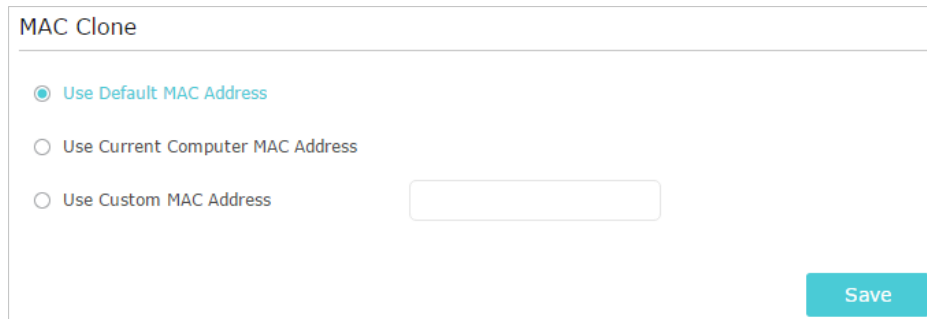

Tips:

- Some ISP will register the MAC address of your computer when you access the internet for the first time through their Cable modem, if you add a router into your network to share your internet connection, the ISP will not accept it as the MAC address is changed, so we need to clone your computer's MAC address to the router.
- The MAC addresses of a computer in wired connection and wireless connection are different.

- Modify the LAN IP address of the router.

Note:

Most TP-Link routers use 192.168.0.1/192.168.1.1 as their default LAN IP address, which may conflict with the IP range of your existing ADSL modem/router. If so, the router is not able to communicate with your modem and you can't access the internet. To resolve this problem, we need to change the LAN IP address of the router to avoid such conflict, for example, 192.168.2.1.

- 1) Visit <http://tplinkwifi.net>, and log in with your TP-Link ID or the password you set for the router.
- 2) Go to [Advanced](#) > [Network](#) > [LAN](#).
- 3) Modify the LAN IP address as the follow picture shows. Here we take 192.168.2.1 as an example.
- 4) Click [Save](#).

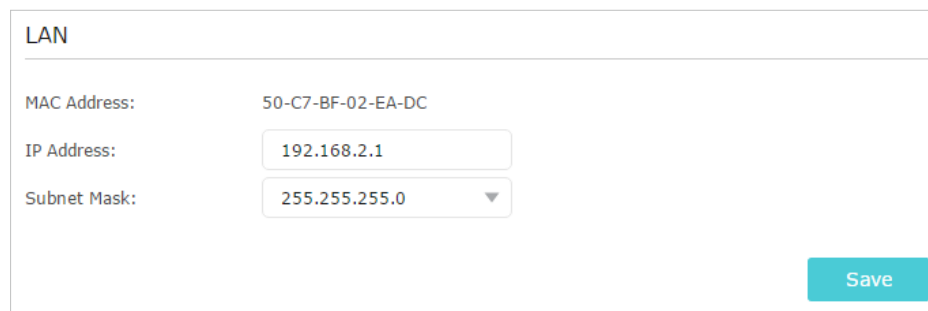

LAN

MAC Address: 50-C7-BF-02-EA-DC

IP Address:

Subnet Mask:

[Save](#)

- Restart the modem and the router.
 - 1) Power off your modem and router, and leave them off for 1 minute.
 - 2) Power on your modem first, and wait about 2 minutes until it get a solid cable or Internet light.
 - 3) Power on the router.
 - 4) Wait another 1 or 2 minutes and check the internet access.
- Double check the internet connection type.
 - 1) Confirm your internet connection type, which can be learned from the ISP.
 - 2) Visit <http://tplinkwifi.net>, and log in with your TP-Link ID or the password you set for the router.
 - 3) Go to [Advanced](#) > [Network](#) > [Internet](#).
 - 4) Select your [Internet Connection Type](#) and fill in other parameters.
 - 5) Click [Save](#).

The screenshot shows the IPv4 configuration page. The 'Internet Connection Type' is set to 'Dynamic IP'. The 'IP Address' field is highlighted in blue. Below the fields are 'Renew' and 'Release' buttons. A red message indicates 'WAN port is unplugged.' At the bottom, there is an 'Advanced' toggle and a 'Save' button.

6) Restart the modem and the router again.

- Please upgrade the firmware of the router.

If you've tried every method above but still cannot access the internet, please contact the technical support.

Q6. What should I do if I cannot find my wireless network or I cannot connect the wireless network?

If you fail to find any wireless network, please follow the steps below:

- Make sure the wireless function of your device is enabled if you're using a laptop with built-in wireless adapter. You can refer to the relevant document or contact the laptop manufacturer.
- Make sure the wireless adapter driver is installed successfully and the wireless adapter is enabled. You can refer to the relevant document or contact the wireless adapter manufacturer.

If you can find other wireless network except your own, please follow the steps below:

- Check the WLAN LED indicator on your wireless router/modem.
- Make sure your computer/device is still in the range of your router/modem. Move it closer if it is currently too far away.
- Go to [Advanced](#) > [Wireless](#) > [Wireless Settings](#), and check the wireless settings. Double check your Wireless Network Name and SSID is not hidden.

Wireless Settings 2.4GHz | 5GHz

Enable Wireless Radio

Network Name (SSID): Hide SSID

Security:

Version: Auto WPA-PSK WPA2-PSK

Encryption: Auto TKIP AES

Password:

Mode:

Channel Width:

Channel:

Transmit Power: Low Middle High

If you can find your wireless network but fail to connect, please follow the steps below:

- **Authenticating problem/password mismatch:**

- 1) Sometimes you will be asked to type in a PIN number when you connect to the wireless network for the first time. This PIN number is different from the Wireless Password/Network Security Key, usually you can only find it on the label of your router.



- 2) If you cannot find the PIN or PIN failed, you may choose [Connecting using a security key instead](#), and then type in the [Wireless Password/Network Security Key](#).
- 3) If it continues to show note of [Network Security Key Mismatch](#), it is suggested to confirm the wireless password of your wireless router.

Note: Wireless Password/Network Security Key is case sensitive.

- **Windows unable to connect to XXXX / Can not join this network / Taking longer than usual to connect to this network:**

- Check the wireless signal strength of your network. If it is weak (1~3 bars), please move the router closer and try again.
- Change the wireless Channel of the router to 1, 6 or 11 to reduce interference from other networks.
- Re-install or update the driver for your wireless adapter of the computer.

COPYRIGHT & TRADEMARKS

Specifications are subject to change without notice.  tp-link is a registered trademark of TP-Link Technologies Co., Ltd. Other brands and product names are trademarks or registered trademarks of their respective holders.

No part of the specifications may be reproduced in any form or by any means or used to make any derivative such as translation, transformation, or adaptation without permission from TP-Link Technologies Co., Ltd. Copyright © 2019 TP-Link Technologies Co., Ltd. All rights reserved.

FCC compliance information statement



Product Name: AC1750 Wireless Dual Band Gigabit Router

Model Number: Archer C7/Archer A7

Component Name	Model
I.T.E. Power Supply	T120150-2B1

Responsible party:

TP-Link USA Corporation, d/b/a TP-Link North America, Inc.

Address: 145 South State College Blvd. Suite 400, Brea, CA 92821

Website: <http://www.tp-link.com/us/>

Tel: +1 626 333 0234

Fax: +1 909 527 6803

E-mail: sales.usa@tp-link.com

This equipment has been tested and found to comply with the limits for a Class B digital device, pursuant to part 15 of the FCC Rules. These limits are designed to provide reasonable protection against harmful interference in a residential installation. This equipment generates, uses and can radiate radio frequency energy and, if not installed and used in accordance with the instructions, may cause harmful interference to radio communications. However, there is no guarantee that interference will not occur in a particular installation. If this equipment does cause harmful interference to radio or television reception, which can be determined by turning the equipment off and on, the user is encouraged to try to correct the interference by one or more of the following measures:

- Reorient or relocate the receiving antenna.
- Increase the separation between the equipment and receiver.
- Connect the equipment into an outlet on a circuit different from that to which the receiver is connected.
- Consult the dealer or an experienced radio/ TV technician for help.

This device complies with part 15 of the FCC Rules. Operation is subject to the following two conditions:

1. This device may not cause harmful interference.
2. This device must accept any interference received, including interference that may cause undesired operation.

Any changes or modifications not expressly approved by the party responsible for compliance could void the user's authority to operate the equipment.

Note: The manufacturer is not responsible for any radio or TV interference caused by unauthorized modifications to this equipment. Such modifications could void the user's authority to operate the equipment.

FCC RF Radiation Exposure Statement

This equipment complies with FCC RF radiation exposure limits set forth for an uncontrolled environment. This device and its antenna must not be co-located or operating in conjunction with any other antenna or transmitter.

"To comply with FCC RF exposure compliance requirements, this grant is applicable to only Mobile Configurations. The antennas used for this transmitter must be installed to provide a separation distance of at least 20 cm from all persons and must not be co-located or operating in conjunction with any other antenna or transmitter."

We, **TP-Link USA Corporation**, has determined that the equipment shown as above has been shown to comply with the applicable technical standards, FCC part 15. There is no unauthorized change is made in the equipment and the equipment is properly maintained and operated.

FCC compliance information statement

Product Name: I.T.E. Power Supply

Model Number: T120150-2B1

Responsible party:

TP-Link USA Corporation, d/b/a TP-Link North America, Inc.

Address: 145 South State College Blvd. Suite 400, Brea, CA 92821

Website: <http://www.tp-link.com/us/>

Tel: +1 626 333 0234

Fax: +1 909 527 6803

E-mail: sales.usa@tp-link.com

This equipment has been tested and found to comply with the limits for a Class B digital device, pursuant to part 15 of the FCC Rules. These limits are designed to provide reasonable protection against harmful interference in a residential installation. This equipment generates, uses and can radiate radio frequency energy and, if not installed and used in accordance with the instructions, may cause harmful interference to radio communications. However, there is no guarantee that interference will not occur in a particular installation. If this equipment does cause harmful interference to radio or television reception, which can be determined by turning the equipment off and on, the user is encouraged to try to correct the interference by one or more of the following measures:

- Reorient or relocate the receiving antenna.
- Increase the separation between the equipment and receiver.
- Connect the equipment into an outlet on a circuit different from that to which the receiver is connected.
- Consult the dealer or an experienced radio/ TV technician for help.

This device complies with part 15 of the FCC Rules. Operation is subject to the following two conditions:

1. This device may not cause harmful interference.
2. This device must accept any interference received, including interference that may cause undesired operation.

Any changes or modifications not expressly approved by the party responsible for compliance could void the user's authority to operate the equipment.

We, **TP-Link USA Corporation**, has determined that the equipment shown as above has been shown to comply with the applicable technical standards, FCC part 15. There is no unauthorized change is made in the equipment and the equipment is properly maintained and operated.

Issue Date: 2019-05-07

CE Mark Warning



This is a class B product. In a domestic environment, this product may cause radio interference, in which case the user may be required to take adequate measures.

OPERATING FREQUENCY(the maximum transmitted power)

2400 MHz -2483.5 MHz (20dBm)

5150 MHz -5250 MHz (23dBm)

EU declaration of conformity

TP-Link hereby declares that the device is in compliance with the essential requirements and other relevant provisions of directives 2014/53/EU, 2009/125/EC and 2011/65/EU.

The original EU declaration of conformity may be found at <http://www.tp-link.com/en/ce>

RF Exposure Information

This device meets the EU requirements (2014/53/EU Article 3.1a) on the limitation of exposure of the general public to electromagnetic fields by way of health protection.

The device complies with RF specifications when the device used at 20 cm from your body.

National restrictions

Attention: This device may only be used indoors in all EU member states and EFTA countries.

	AT	BE	BG	CH	CY	CZ	DE	DK
	EE	EL	ES	FI	FR	HR	HU	IE
	IS	IT	LI	LT	LU	LV	MT	NL
	NO	PL	PT	RO	SE	SI	SK	UK

Canadian Compliance Statement

This device contains licence-exempt transmitter(s)/receiver(s) that comply with Innovation, Science and Economic Development Canada's licence-exempt RSS(s). Operation is subject to the following two conditions:

1. This device may not cause interference.
2. This device must accept any interference, including interference that may cause undesired operation of the device.

L'émetteur/récepteur exempt de licence contenu dans le présent appareil est conforme aux CNR d'Innovation, Sciences et Développement économique Canada applicables

aux appareils radio exempts de licence. L'exploitation est autorisée aux deux conditions suivantes :

1. L'appareil ne doit pas produire de brouillage;
2. L'appareil doit accepter tout brouillage radioélectrique subi, même si le brouillage est susceptible d'en compromettre le fonctionnement.

Caution:

1. The device for operation in the band 5150–5250 MHz is only for indoor use to reduce the potential for harmful interference to co-channel mobile satellite systems;

Avertissement:

1. Le dispositif fonctionnant dans la bande 5150-5250 MHz est réservé uniquement pour une utilisation à l'intérieur afin de réduire les risques de brouillage préjudiciable aux systèmes de satellites mobiles utilisant les mêmes canaux;

Radiation Exposure Statement:

This equipment complies with IC radiation exposure limits set forth for an uncontrolled environment. This equipment should be installed and operated with minimum distance 20cm between the radiator & your body.

Déclaration d'exposition aux radiations:

Cet équipement est conforme aux limites d'exposition aux rayonnements IC établies pour un environnement non contrôlé. Cet équipement doit être installé et utilisé avec un minimum de 20 cm de distance entre la source de rayonnement et votre corps.

Industry Canada Statement

CAN ICES-3 (B)/NMB-3(B)

Korea Warning Statements:

해당 무선설비는 운용중 전파혼신 가능성이 있음.

NCC Notice & BSMI Notice:

注意！

依據 低功率電波輻射性電機管理辦法

第十二條 經型式認證合格之低功率射頻電機，非經許可，公司、商號或使用者均不得擅自變更頻率、加大功率或變更原設計之特性或功能。

第十四條 低功率射頻電機之使用不得影響飛航安全及干擾合法通信；經發現有干擾現象時，應立即停用，並改善至無干擾時方得繼續使用。前項合法通信，指依電信規定作業之無線電信。低功率射頻電機需忍受合法通信或工業、科學以及醫療用電波輻射性電機設備之干擾。

4.7.9.1應避免影響附近雷達系統之操作。

4.7.9.2高增益指向性天線只得應用於固定式點對點系統。

安全諮詢及注意事項

- 請使用原裝電源供應器或只能按照本產品注明的電源類型使用本產品。
- 清潔本產品之前請先拔掉電源線。請勿使用液體、噴霧清潔劑或濕布進行清潔。
- 注意防潮，請勿將水或其他液體潑灑到本產品上。
- 插槽與開口供通風使用，以確保本產品的操作可靠並防止過熱，請勿堵塞或覆蓋開口。
- 請勿將本產品置放於靠近熱源的地方。除非有正常的通風，否則不可放在密閉位置中。
- 請不要私自打開機殼，不要嘗試自行維修本產品，請由授權的專業人士進行此項工作。

限用物質含有情況標示聲明書

產品元件名稱	限用物質及其化學符號					
	鉛 Pb	鎘 Cd	汞 Hg	六價鉻 CrVI	多溴聯苯 PBB	多溴二苯醚 PBDE
PCB	○	○	○	○	○	○
外殼	○	○	○	○	○	○
電源適配器	-	○	○	○	○	○

備考1. 超出0.1 wt %” 及 “超出0.01 wt %” 系指限用物質之百分比含量超出百分比含量基準值。

備考2. “○” 系指該項限用物質之百分比含量未超出百分比含量基準值。

備考3. “-” 系指該項限用物質為排除項目。



Продукт сертифіковано згідно с правилами системи УкрСЕПРО на відповідність вимогам нормативних документів та вимогам, що передбачені чинними законодавчими актами України.





Safety Information

- Keep the device away from water, fire, humidity or hot environments.
- Do not attempt to disassemble, repair, or modify the device.
- Do not use damaged charger or USB cable to charge the device.
- Do not use any other chargers than those recommended
- Do not use the device where wireless devices are not allowed.
- Adapter shall be installed near the equipment and shall be easily accessible.

-  Use only power supplies which are provided by manufacturer and in the original packing of this product. If you have any questions, please don't hesitate to contact us.

Explanations of the symbols on the product label

Symbol	Explanation
	DC voltage
	Indoor use only
	<p>RECYCLING</p> <p>This product bears the selective sorting symbol for Waste electrical and electronic equipment (WEEE). This means that this product must be handled pursuant to European directive 2012/19/EU in order to be recycled or dismantled to minimize its impact on the environment.</p> <p>User has the choice to give his product to a competent recycling organization or to the retailer when he buys a new electrical or electronic equipment.</p>